

LIGHT·POINT®
C O P E N H A G E N



DESIGN BY
STUDIO F. A. PORSCHE

LIGHT-POINT | Design by Studio F. A. Porsche



LIGHT-POINT | Design by Studio F. A. Porsche

In 2018, LIGHT-POINT devised a global growth strategy centred on the “Premium Design” to position the brand in a class of its own. In the last four years, LIGHT-POINT has grown significantly and its collections, developed by its in-house design team, have garnered many international accolades.

In 2021, LIGHT-POINT became a member of an exclusive group of companies to partner with the internationally recognised premium design consultancy, Studio F. A. Porsche. The strategic vision of this partnership is to enhance the premium design quality of LIGHT-POINT’s product collection.

For the first two design collections, BLADE and INLAY, Studio F. A. Porsche dreamt up an innovative yet contemporary lighting collection that expresses its design DNA.

“We’re excited to announce the collaboration with Studio F. A. Porsche, which has been part of our design strategy developed a few years ago.” says Ronni Gol, Owner and CEO of LIGHT-POINT. “Studio F. A. Porsche is recognised globally for its superb design and quality, values shared by us. This made our collaboration and relationship with its skilled design team a natural fit for our company.”

contents

Studio F. A. Porsche	06
LIGHT-POINT	11
The partnership	12
BLADE collection	14
BLADE T1 & T2	20
BLADE F1	21
BLADE C1 & C1+	24
BLADE S2	27
INLAY collection	34
INLAY C1, C2 & C3	38
INLAY W1 & W2	42
INLAY T2	45
INLAY S1400 & S1900	48
INLAY F1	51
SMART TUNE	54
Overview	60

About Studio F. A. Porsche

Professor Ferdinand Alexander Porsche, grandson of the founder of Porsche, always sought the unusual – successfully so. He developed the Porsche 911 design, which fast became the epitome of the exceptional sports car and, like many other items designed by him, a design classic.

In 1972, he left the family business to set up his own world-renowned design studio, now called Studio F. A. Porsche. From then on, he applied his design principles beyond automotive design. The aesthetic calibre of his unmistakable lines is evident from his very first work for his company. It remains the studio's guiding design philosophy, which can be summed up as "Always get the most out of everything, optimise function and reduce every design to its essentials".

Studio F. A. Porsche is part of the Porsche Group, and its HQ is located in Zell Am See, Austria.

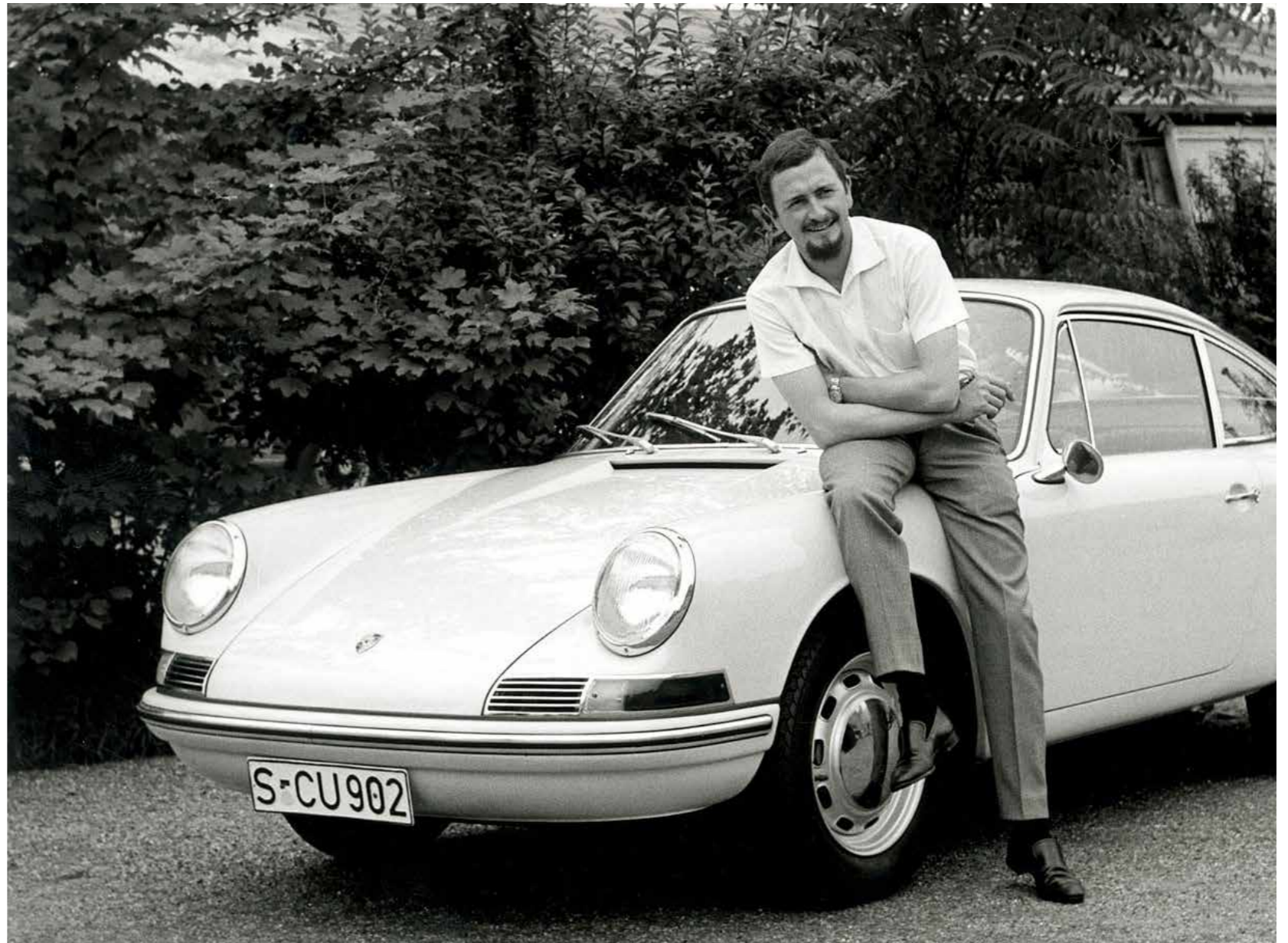





About LIGHT-POINT

LIGHT-POINT has produced innovative lighting of superior quality and craftsmanship since 1995. Over the past 27 years, it has created an extensive product range in a distinctly Danish, ultra-modern ever-evolving style.

The company broadens the perception of what good lighting design can do. Our products express a consistent approach – our quest for perfect forms, the latest in LED technology and aesthetically timeless and minimal design. Every LIGHT-POINT product – be it bathroom lighting, table or pendant lights for living rooms or built-in ceiling and wall lights – has a unique emotive impact.

Ronni Gol is the founder and CEO of LIGHT-POINT, whose vision is to create innovative lighting with a global appeal.

The partnership

The whole design process has involved no compromises and been a journey towards realising a series of lights focused on a clean-lined, pure and unfussy design language, coupled with outstanding performance. Our goal was to keep pushing the boundaries of high-quality products, great lighting and subtle design. The dedication and commitment shown by both LIGHT-POINT and Studio F. A. Porsche played an extremely important role in helping us achieve our goal of producing a portfolio of several collections.

Everyone in the team performed above and beyond all expectations and we intend to keep fostering this collaboration for years to come

“It’s rare that a designer’s approach, attitude and level of sophistication all match up on this scale. We had no difficulty convincing LIGHT-POINT of the best possible solution with regard to the range’s execution,”
says Christian Schwamkrug, Design Director at Studio F. A. Porsche.

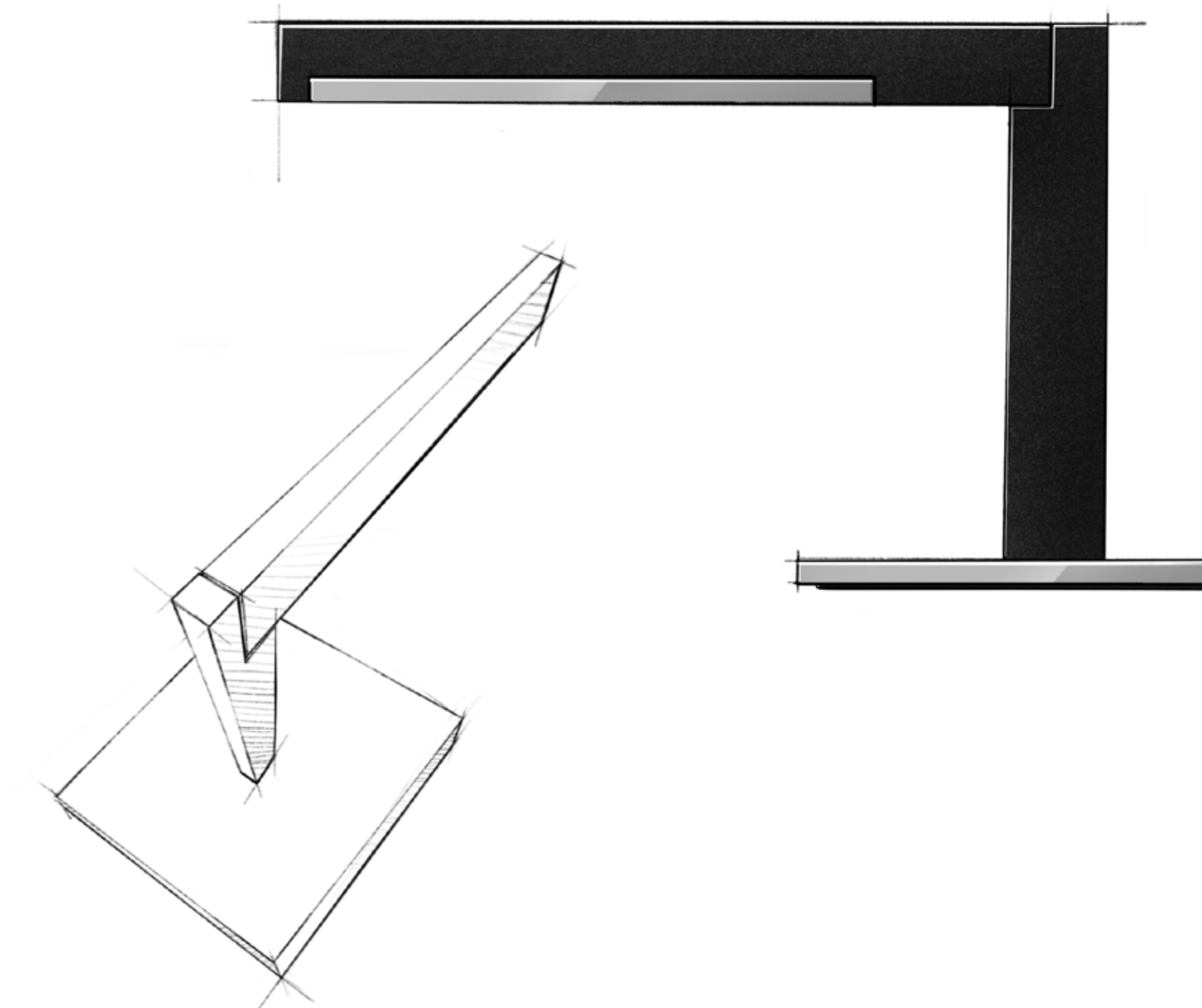



BLADE collection



BLADE collection

Integrated symmetry

BLADE collection

BLADE is based on precision, geometry and clean lines. Comprising two cylinders connected by a moveable, linear core, its integrated yet hidden functionalities play an important role. All hinges and cables are integrated into the design and so are invisible. Every element has been stripped down to its essential function and is there for a reason.

When you tilt the arm and rotate the shade, BLADE casts a beautiful light, regardless of where it's positioned. It's a timeless collection that celebrates the high quality of its material, emphasised by its slender, elegant silhouette. With its pure design and sleek form, it's sure to add style to any room.

The collection encompasses table, floor, pendant and wall lights. All lamps come with LEDs as well as an optical glass providing a wide, glare-free light, and are ideally suited for both the residential and hospitality sectors.



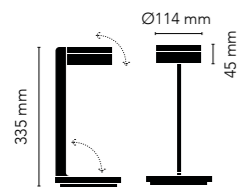

BLADE T1 SLIM

9W LED - 220-240V - IP20 - 2700/3000K
 CRI: > 90 - Dimmable - Material: Aluminium/ Glass
 Lumen 990lm (nominal)



MATT BLACK/ SATIN GOLD	900120	NEW
MATT BLACK/ SATIN SILVER	900121	NEW

DKK	4.556,- EX VAT / 5.695,- INCL VAT
SEK	6.908,- EX VAT / 8.635,- INCL VAT
EURO	633,- EX VAT

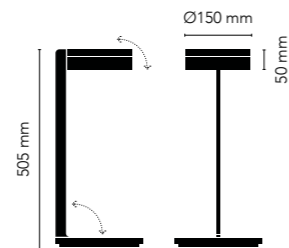

BLADE T2 SLIM

12,5W LED - 220-240V - IP20 - 2700/3000K
 CRI: > 90 - Dimmable - Material: Aluminium/ Glass
 Lumen 1375lm (nominal)



MATT BLACK/ SATIN GOLD	900130	NEW
MATT BLACK/ SATIN SILVER	900131	NEW

DKK	6.316,- EX VAT / 7.895,- INCL VAT
SEK	9.572,- EX VAT / 11.965,- INCL VAT
EURO	877,- EX VAT

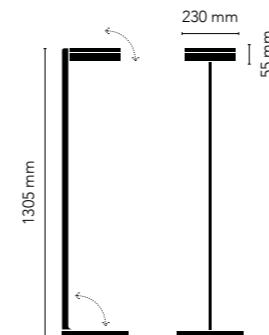

BLADE F1 SLIM

12,5W LED - 220-240V - IP20 - 2700/3000K
 CRI: > 90 - Dimmable - Material: Aluminium/ Glass
 Lumen 1375lm (nominal)



MATT BLACK/ SATIN GOLD	900160	NEW
MATT BLACK/ SATIN SILVER	900161	NEW

DKK	11.196,- EX VAT / 13.995,- INCL VAT
SEK	16.964,- EX VAT / 21.205,- INCL VAT
EURO	1.555,- EX VAT



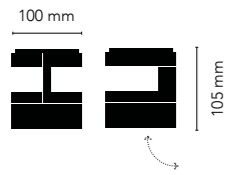

BLADE C1 SLIM

8,4W LED - 220-240V - IP20 - 2700/3000K
 CRI: > 90 - Dimmable - Material: Aluminium/ Glass
 Lumen 924lm (nominal)



MATT BLACK/ SATIN GOLD	900240	NEW
MATT BLACK/ SATIN SILVER	900241	NEW

DKK	2.956,- EX VAT / 3.695,- INCL VAT
SEK	4.484,- EX VAT / 5.605,- INCL VAT
EURO	411,- EX VAT

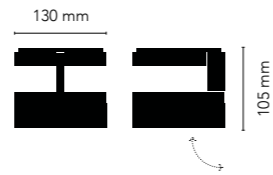

BLADE C1+ SLIM

13,3WLED - 220-240V - IP20 - 2700/3000K
 CRI: > 90 - Dimmable - Material: Aluminium/ Glass
 Lumen 1463lm (nominal)



MATT BLACK/ SATIN GOLD	900250	NEW
MATT BLACK/ SATIN SILVER	900251	NEW

DKK	3.596,- EX VAT / 4.495,- INCL VAT
SEK	5.452,- EX VAT / 6.815,- INCL VAT
EURO	499,- EX VAT



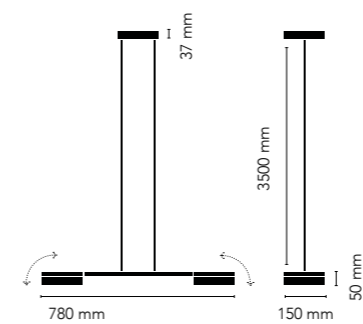

BLADE S2 SLIM

2x16W LED - 220-240V - IP20 - 2700-6500K
 CRI: > 90 - Dimmable - Material: Aluminium/ Glass
 Lumen 3520lm (nominal)

SMART TUNE™
 POWERED BY CASAMBI



MATT BLACK/ SATIN GOLD	900200	NEW
MATT BLACK/ SATIN SILVER	900201	NEW

DKK	11.996,- EX VAT / 14.995,- INCL VAT
SEK	18.180,- EX VAT / 22.725,- INCL VAT
EURO	1.666,- EX VAT



Timeless design

“BLADE is about the elegance of a purist yet sophisticated geometry. Reducing a light to its essential parts with a single linear element that connects solid metal discs, resulting in an intriguing object that celebrates precision, high quality and timeless design”

Daniel Bründl, Senior Designer at Studio F. A. Porsche.







INLAY collection

"The INLAY concept is a bold statement – it deals with the absence of design at first glance. It's a remarkable example of the emphasis placed on detail and workmanship. Mastering this fine line has taken courage and been a huge challenge" says Christian Schwamkrug, Design Director at Studio F. A. Porsche.



One fine line!

INLAY collection

INLAY is a design based on one core principle – a straight line – which is its very essence. The collection is supremely minimalist yet highlights the contrasts between similar materials – Matt Black Aluminium combined with Satin Gold or Matt Silver Aluminium.

INLAY is a masterstroke in precision, its design language defined by the interplay between its materials – the result of many hours spent refining it down to every detail.

INLAY is a stylish design with a clean, architectural form, free of superfluous elements. Its linear form casts an even light along the entire length of the lamp, which incorporates a touch or a touchless sensor to switch it on or off, and dim the light.

The INLAY collection comprises floor, table, wall and pendant lights. All pendants feature a built-in SMART TUNE solution, allowing you to switch the light on and off and control its colour temperature and brightness, all via the Casambi app.

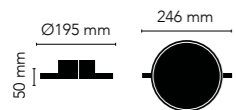

INLAY ROUND C1

12W LED - 220-240V - IP20 - 2700/3000K
 CRI: > 90 - Dimmable - Material: Aluminium/ Acrylic
 Lumen 1320lm (nominal)



MATT BLACK/ SATIN GOLD	900000	NEW
MATT BLACK/ SATIN SILVER	900001	NEW

DKK	3.196,- EX VAT / 3.995,- INCL VAT
SEK	4.844,- EX VAT / 6.055,- INCL VAT
EURO	444,- EX VAT

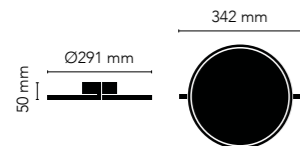

INLAY ROUND C2

18W LED - 220-240V - IP20 - 2700/3000K
 CRI: > 90 - Dimmable - Material: Aluminium/ Acrylic
 Lumen 1980lm (nominal)



MATT BLACK/ SATIN GOLD	900010	NEW
MATT BLACK/ SATIN SILVER	900011	NEW

DKK	4.396,- EX VAT / 5.495,- INCL VAT
SEK	6.668,- EX VAT / 8.335,- INCL VAT
EURO	611,- EX VAT



INLAY ROUND C3

25W LED - 220-240V - IP20 - 2700/3000K
 CRI: > 90 - Dimmable - Material: Aluminium/ Acrylic
 Lumen 2750lm (nominal)



MATT BLACK/ SATIN GOLD	900020	NEW
MATT BLACK/ SATIN SILVER	900021	NEW

DKK	5.596,- EX VAT / 6.995,- INCL VAT
SEK	8.484,- EX VAT / 10.605,- INCL VAT
EURO	777,- EX VAT





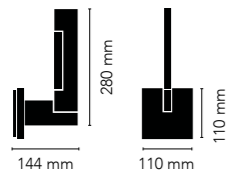

INLAY W1

6W LED - 220-240V - IP20 - 2700/3000K
 CRI: > 90 - Dimmable - Material: Aluminium/ Acrylic
 Lumen 660lm (nominal)



MATT BLACK/ SATIN GOLD	900030	NEW
MATT BLACK/ SATIN SILVER	900031	NEW

DKK	3.196,- EX VAT / 3.995,- INCL VAT
SEK	4.844,- EX VAT / 6.055,- INCL VAT
EURO	444,- EX VAT

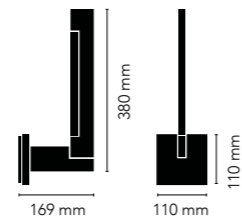

INLAY W2

9W LED - 220-240V - IP20 - 2700/3000K
 CRI: > 90 - Dimmable - Material: Aluminium/ Acrylic
 Lumen 990lm (nominal)



MATT BLACK/ SATIN GOLD	900040	NEW
MATT BLACK/ SATIN SILVER	900041	NEW

DKK	3.916,- EX VAT / 4.895,- INCL VAT
SEK	5.940,- EX VAT / 7.425,- INCL VAT
EURO	544,- EX VAT



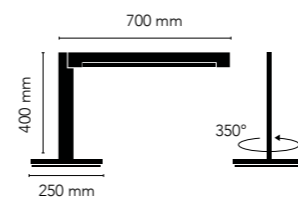

INLAY T2

15W LED - 220-240V - IP20 - 2700/3000K
 CRI: > 90 - Dimmable - Material: Aluminium/ Glass
 Lumen 1500lm (nominal)

SWITCH TUNE™



MATT BLACK/ SATIN GOLD	900050	NEW
MATT BLACK/ SATIN SILVER	900051	NEW
SATIN GOLD/ SATIN GOLD	900052	NEW

DKK	6.796,- EX VAT / 8.495,- INCL VAT
SEK	10.300,- EX VAT / 12.875,- INCL VAT
EURO	944,- EX VAT



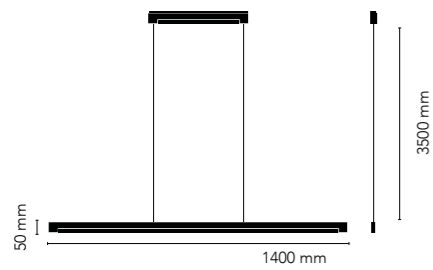

INLAY S1400

30W LED - 220-240V - IP20 - 2700-6500K
 CRI: > 90 - Dimmable - Material: Aluminium/ Acrylic
 Lumen 3300lm (nominal)



MATT BLACK/ SATIN GOLD	900090	NEW
MATT BLACK/ SATIN SILVER	900091	NEW

DKK	10.396,- EX VAT / 12.995,- INCL VAT
SEK	15.756,- EX VAT / 19.695,- INCL VAT
EURO	1.444,- EX VAT

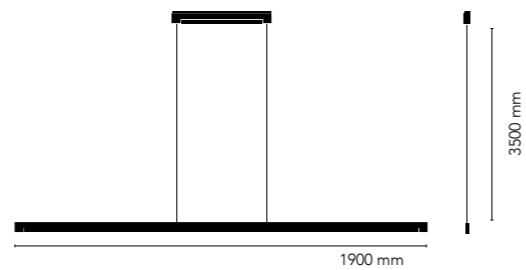

INLAY S1900

38W LED - 220-240V - IP20 - 2700-6500K
 CRI: > 90 - Dimmable - Material: Aluminium/ Acrylic
 Lumen 4180lm (nominal)



MATT BLACK/ SATIN GOLD	900100	NEW
MATT BLACK/ SATIN SILVER	900101	NEW

DKK	12.796,- EX VAT / 15.995,- INCL VAT
SEK	19.388,- EX VAT / 24.235,- INCL VAT
EURO	1.777,- EX VAT



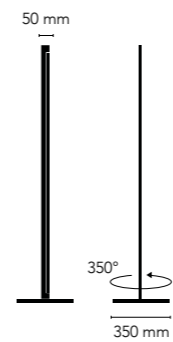

INLAY F1

21W LED - 220-240V - IP20 - 2700/3000K
 CRI: > 90 - Dimmable - Material: Aluminium/ Acrylic
 Lumen 2100lm (nominal)

SWITCH TUNE™



MATT BLACK/ SATIN GOLD	900070	NEW
MATT BLACK/ SATIN SILVER	900071	NEW
SATIN GOLD/ SATIN GOLD	900072	NEW

DKK	12.796,- EX VAT / 15.995,- INCL VAT
SEK	19.388,- EX VAT / 24.235,- INCL VAT
EURO	1.777,- EX VAT

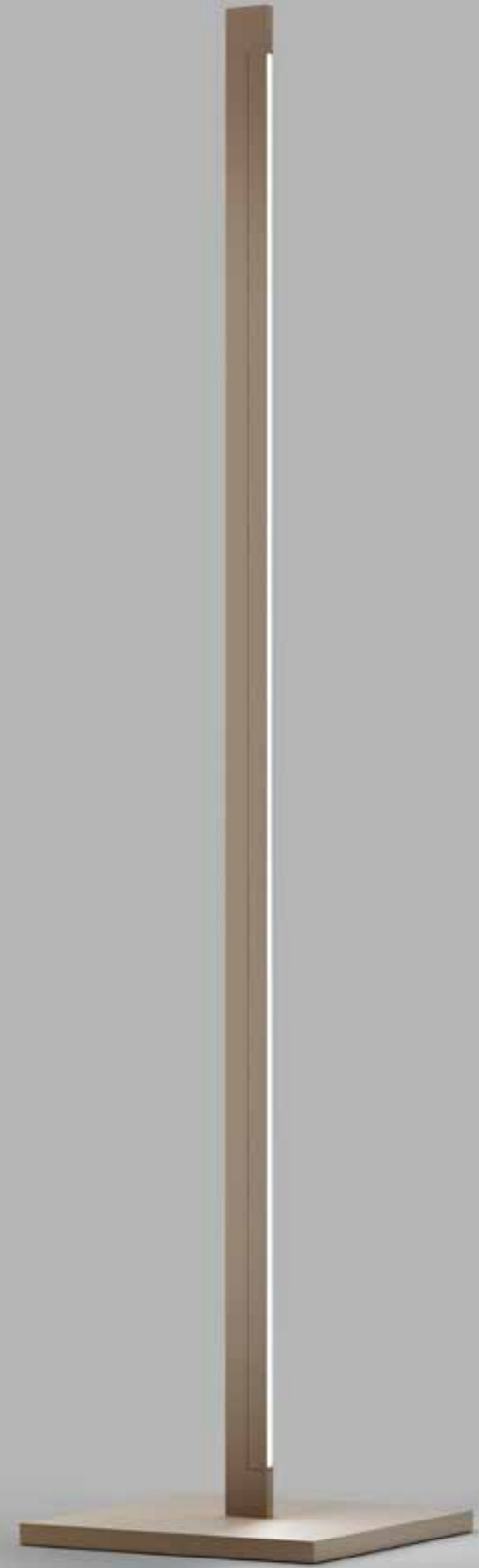

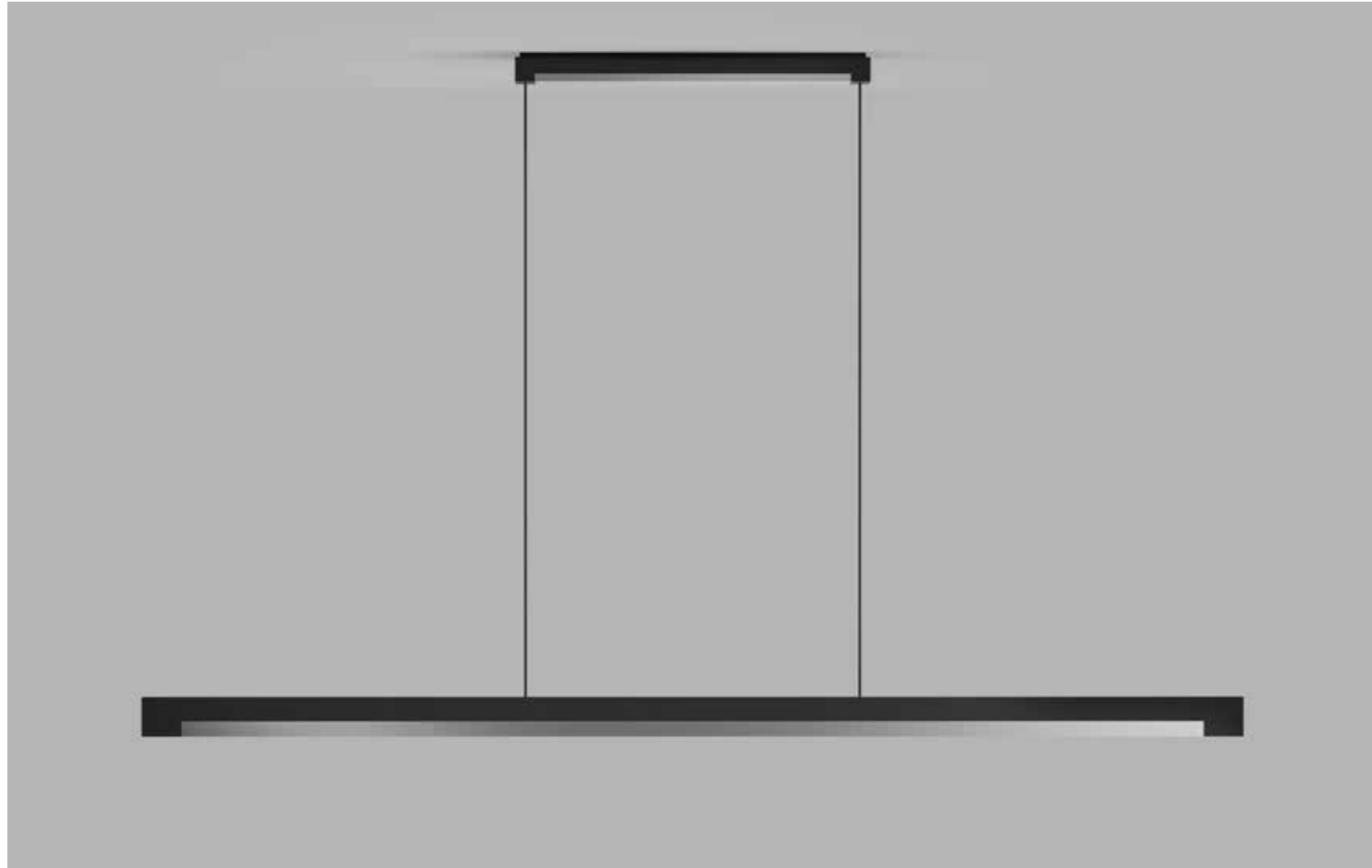

SMART TUNE



SMART TUNE
powered by Casambi

SMART TUNE
POWERED BY CASAMBI

Light isn't just light. It creates atmosphere and is versatile, providing the perfect atmosphere for any occasion. That is why a selection of our Studio F. A. Porsche lights incorporate SMART TUNE powered by Casambi – an app that allows you to operate your lamps with ease using your smartphone. The app will switch your light on and off, adjust its brightness and control the colour temperature.

Here's to
at least
seven
years' peace
of mind

LIGHT-POINT guarantees you the highest quality standards in the manufacturing of lighting, which gives you greater value for longer. All of its designs come with a seven-year warranty.



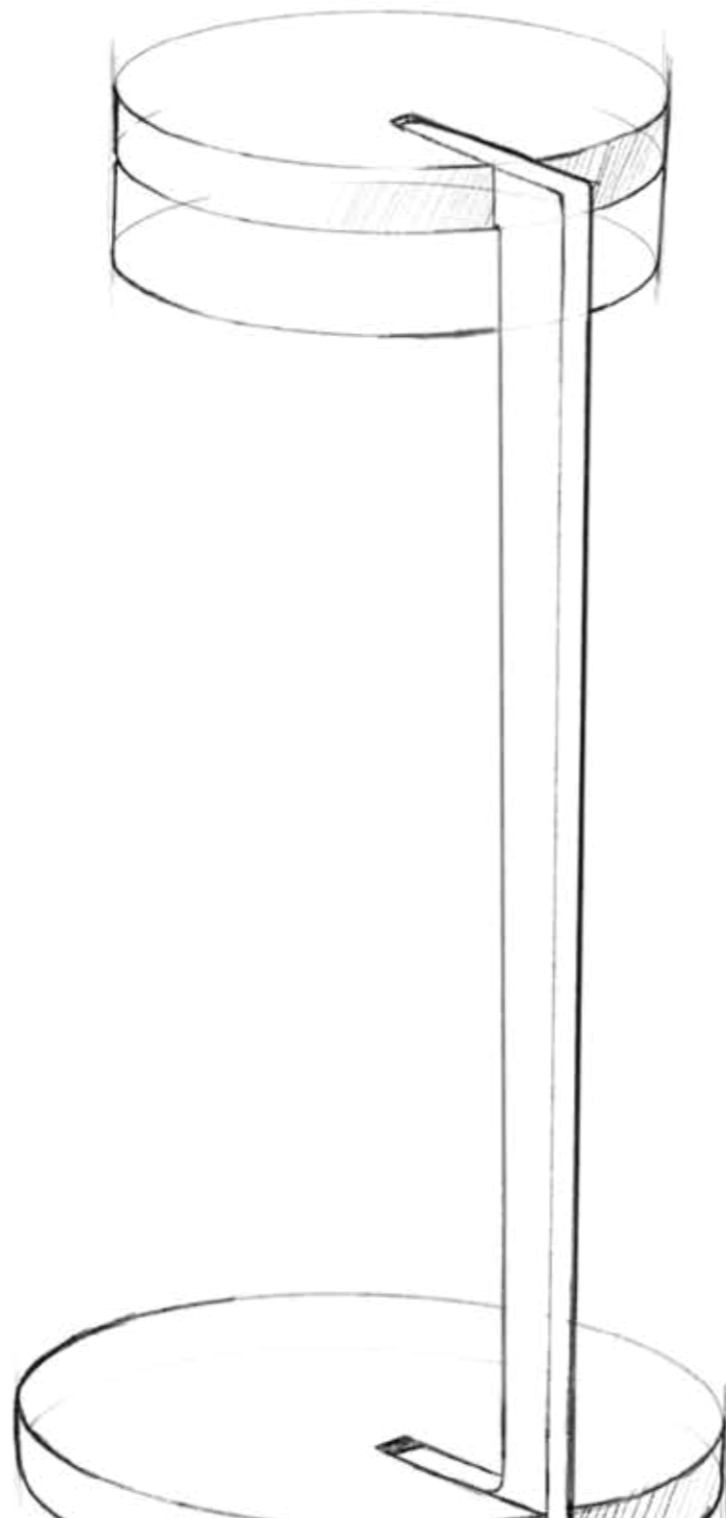
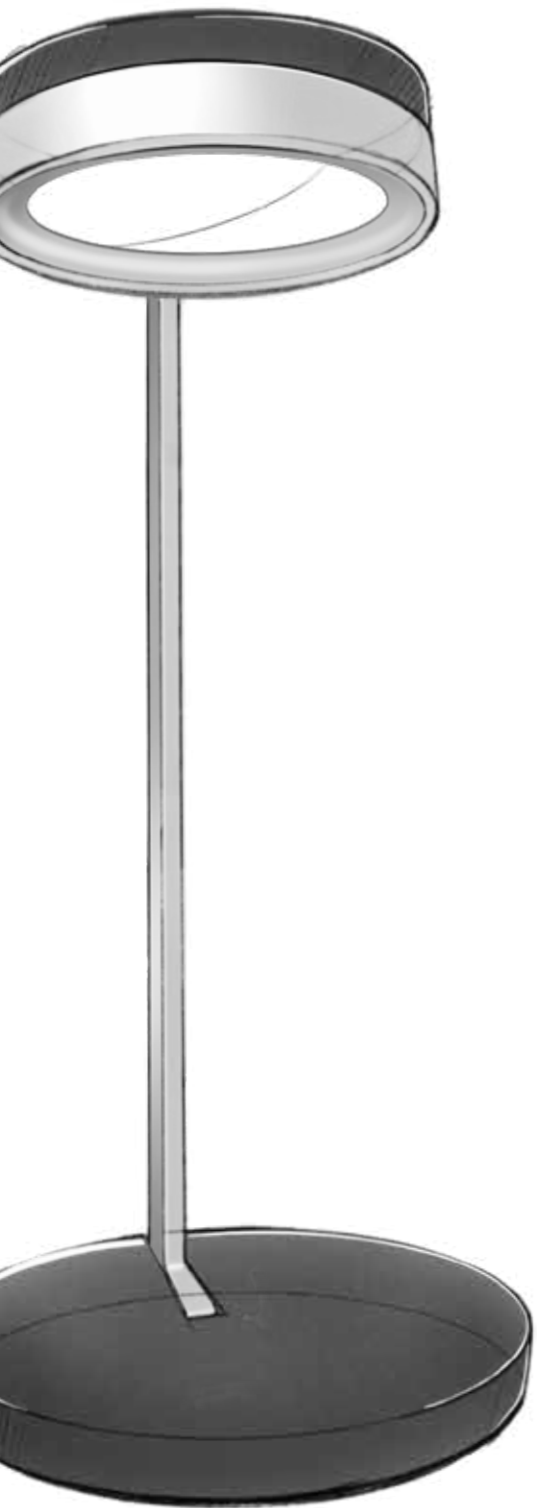

A collection of subtle designs

“There’s a symbiotic relationship between the design languages of LIGHT-POINT and Studio F. A. Porsche. Yet the subtle design details and exquisite materials and finishes found in this collection make it stand out in our product portfolio”
says Head Designer Nital Patel at LIGHT-POINT.

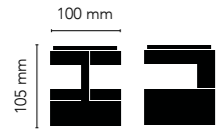

BLADE C1 SLIM
8.4W LED - 220-240V

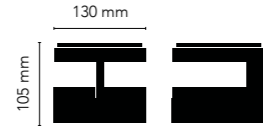

BLADE C1+ SLIM
13.3W LED - 220-240V

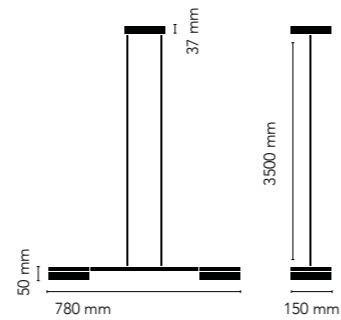

BLADE S2 SLIM
2x16W LED - 220-240V

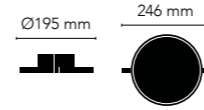

INLAY ROUND C1
12W LED - 220-240V

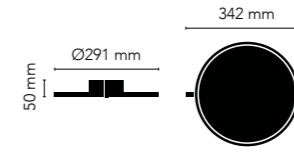

INLAY ROUND C2
18W LED - 220-240V



INLAY ROUND C3
25W LED - 220-240V

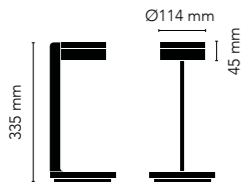

BLADE T1 SLIM
9W LED - 220-240V

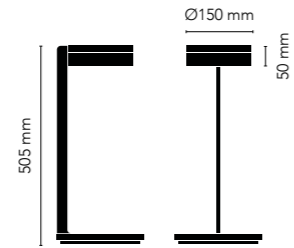

BLADE T2 SLIM
12.5W LED - 220-240V

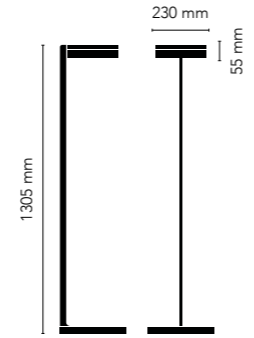

BLADE F1 SLIM
12.5W LED - 220-240V

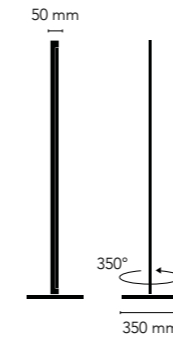

INLAY F1
21W LED - 220-240V

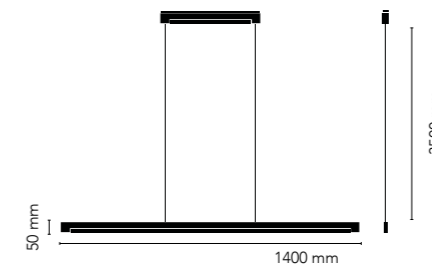

INLAY S1400
30W LED - 220-240V

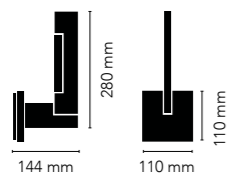

INLAY W1
6W LED - 220-240V

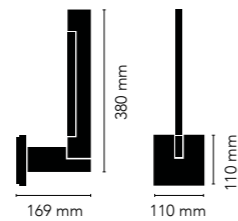

INLAY W2
9W LED - 220-240V

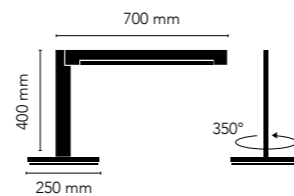

INLAY T2
15W LED - 220-240V

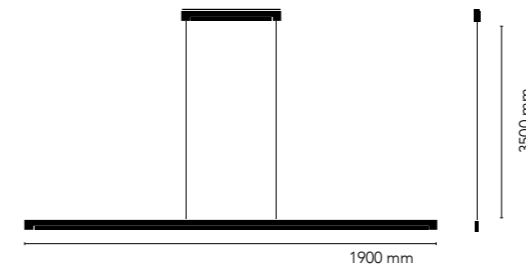

INLAY S1900
38W LED - 220-240V



General terms of sale and delivery

The following terms and conditions cover all deliveries and services from LIGHT-POINT A/S, unless other terms have been agreed upon in writing.

Tender

A tender is binding for three weeks from the date of the tender.

Dispatch/return of goods

Delivery will be EXW LIGHT-POINT A/S' warehouse (Incoterms 2000) unless other terms have been explicitly agreed upon. When buying any of LIGHT-POINT A/S' goods for resale buyer shall defray all freight charges himself.

Dispatch will take place at buyers' own account and risk. When delivery has been agreed to be free of carriage the cost of dispatch is included in the price and the dispatch will be at the risk of LIGHT-POINT A/S. Buyer is only entitled to annul the order due to delay provided delivery is delayed for more than 30 days. Returned goods will only be received when prior agreement of return has been reached and then only in the original wrapping and in an undamaged state. A copy of the delivery note or the invoice must accompany the returned goods.

Erroneous orders for standard goods will be deducted 20% for handling and control. Special goods, procured goods and unwrapped light sources will not be accepted for return.

Prices

All prices are current prices stated in DKK exclusive VAT, government taxes and light sources unless otherwise stated. All prices are stated without prejudice to printing errors, price changes and discontinued goods.

Payment

Unless otherwise stated in LIGHT-POINT A/S' tender or other written agreement our terms of payment are net cash at delivery/collection. At delay in payment a fee of DKK 100.00 and interest of 2% per commencing month will be added.

Notification of defects

Buyer is obligated to examine the goods immediately after receiving them. Notification of defects must be given to LIGHT-

POINT A/S within 8 days of delivery. If buyer does not notify LIGHT-POINT A/S of defects within this time-limit he will not be able to cite any defects at a later date. Expenses incurred by buyer in connection with cited defects are not covered by LIGHT-POINT A/S unless LIGHT-POINT A/S has received the notification of defects and has given a written acceptance to cover the costs.

Warranty

Products which have a manufacturing fault or a flaw in the material will be repaired without cost or exchanged in accordance with the rules in the Danish Sale of Goods Act and to the same extent that the warranty from sub-suppliers covers. Light sources are not covered by warranty.

Exemption of liability

Non-fulfilment including delay or delivery of defective goods will only justify buyer compensation provided buyer documents that the non-fulfilment is caused by gross negligence on the part of LIGHT-POINT A/S. However LIGHT-POINT A/S is in no case responsible for operating loss, loss of time, loss of profits or other like indirect losses including daily fines inflicted on buyer.

Product liability

The company is only responsible for product liability in accordance to the rules in the Danish Product Liability Act. Beyond this the company is not responsible for product liability.

Disputes

Disagreements in connection with the cooperation of the parties with reference to this agreement must be solved according to Danish law, in as much as the parties agree that the venue shall be the Maritime and Commercial High Court in Copenhagen or alternatively the City Court of Copenhagen.

Copenhagen K, 1st of September 2022.

#lightpointcom

info@light-point.com
www.light-point.com

LIGHT-POINT is a registered trademark
of NORDIC LIVING GROUP.

© LIGHT-POINT 2022. All rights reserved.

LIGHT-POINT believes that all information in this publication is correct at the
time of printing, but is not responsible for accuracy of information published.
All information is subject to change without notice.

