

MOON

COLOR TW TB

LED CEILING RECESSED

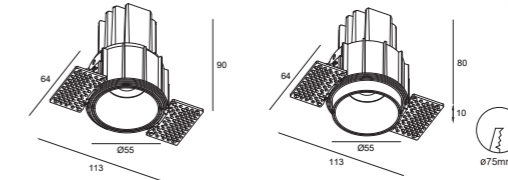
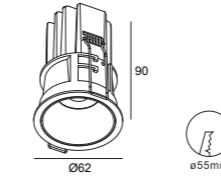
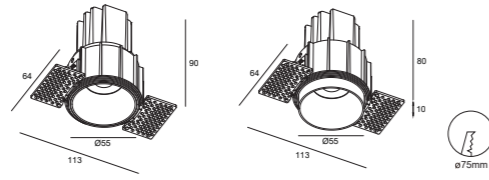
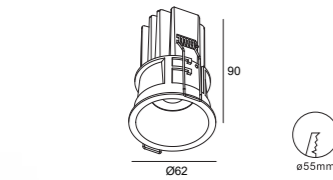
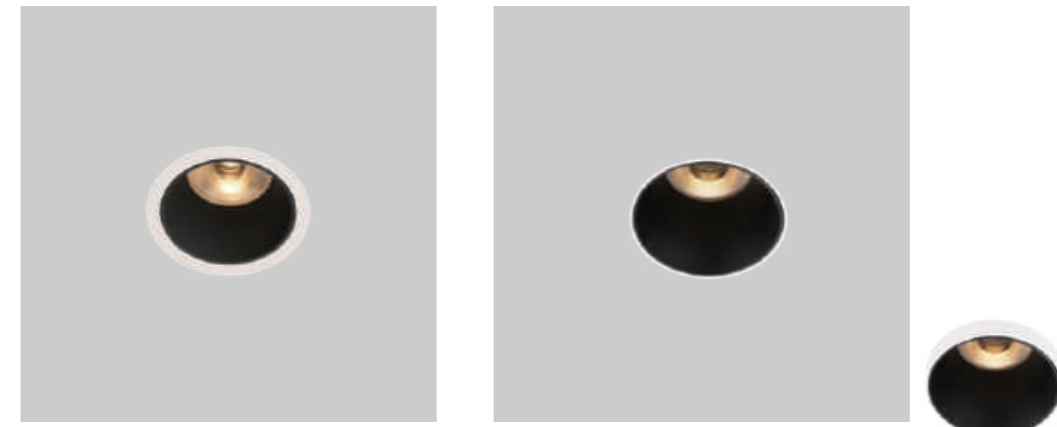
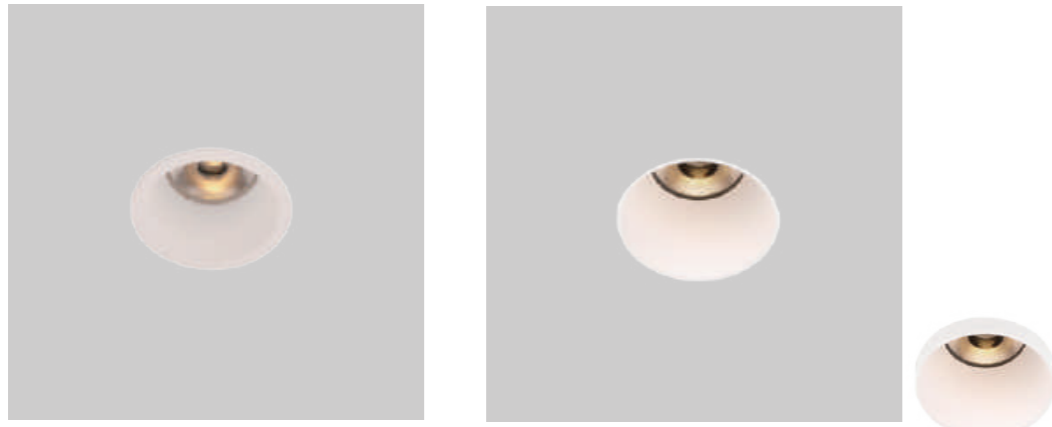

DL1249

Power :1X7W/350mA/Max.19V
:1X10W/500mA/Max.19V
CCT :2700/3000/4000K
Flux :630lm/960lm
CRI :≥92
Cutout :ø55mm

DL1251

Power :1X7W/350mA/Max.19V
:1X10W/500mA/Max.19V
CCT :2700/3000/4000K
Flux :630lm/960lm
CRI :≥92
Cutout :ø75mm

.DL1250

Power :1X7W/350mA/Max.19V
:1X10W/500mA/Max.19V
CCT :2700/3000/4000K
Flux :630lm/960lm
CRI :≥92
Cutout :ø55mm

.DL1252

Power :1X7W/350mA/Max.19V
:1X10W/500mA/Max.19V
CCT :2700/3000/4000K
Flux :630lm/960lm
CRI :≥92
Cutout :ø75mm

Beam angle :
15° 24° 36° 55°



Beam angle :
15° 24° 36° 55°



Beam angle :
15° 24° 36° 55°



Beam angle :
15° 24° 36° 55°

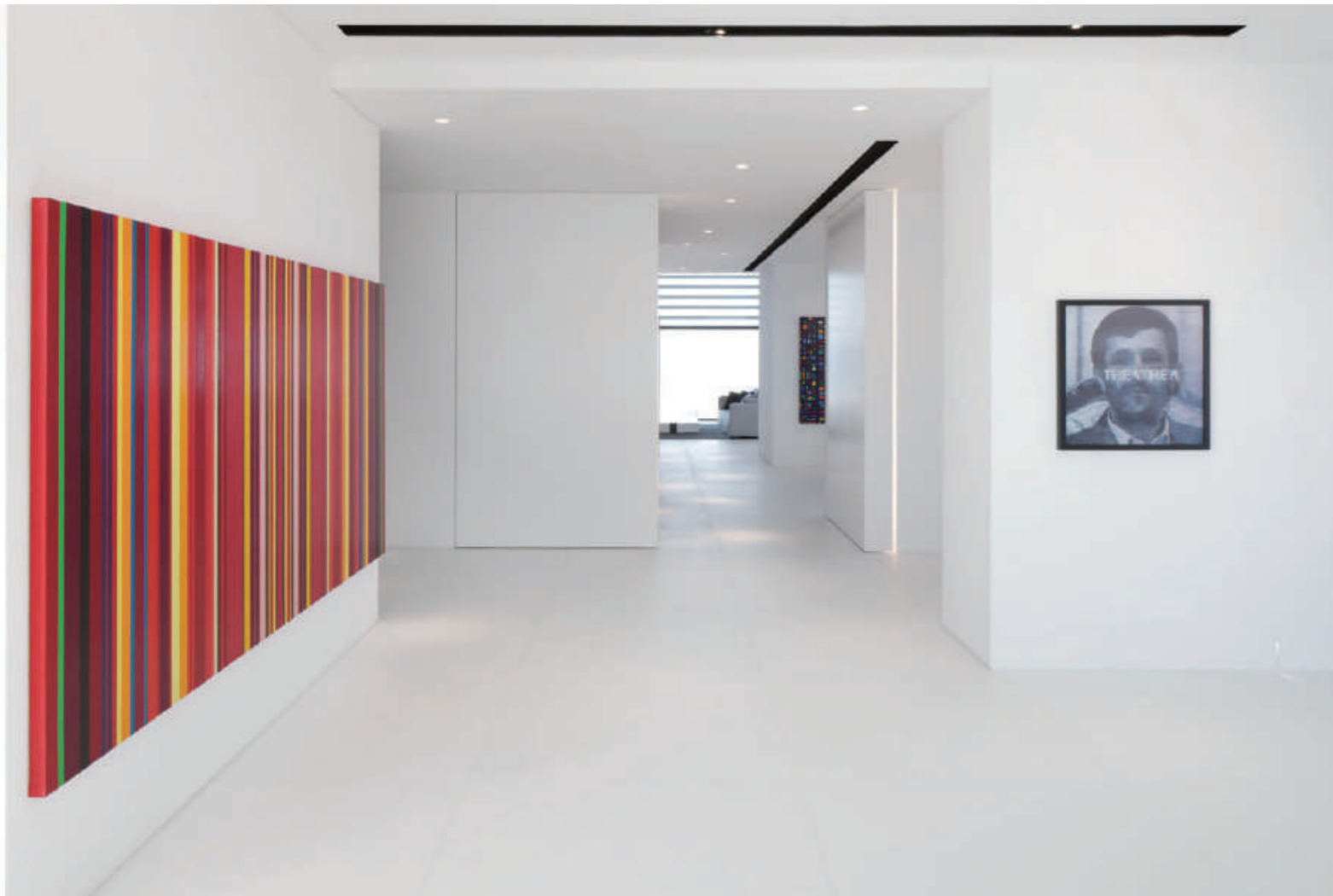

Reflector:



MOON

COLOR TW TB AB

LED CEILING RECESSED

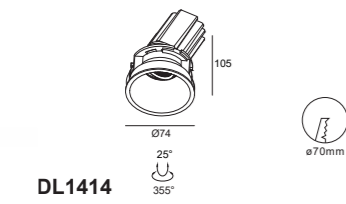
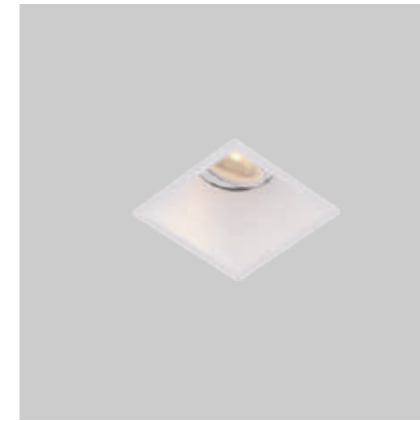

DL1414
 Power :1X7W/350mA/Max.19V
 1X10W/500mA/Max.19V
 CCT :2700/3000/4000K
 Flux :630lm/960lm
 CRI :≥92
 Cutout :ø70mm

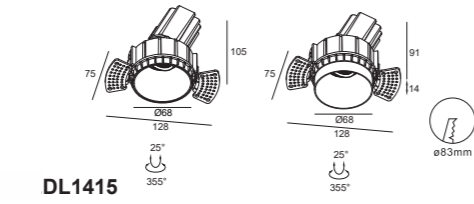
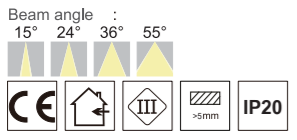

DL1415
 Power :1X7W/350mA/Max.19V
 1X10W/500mA/Max.19V
 CCT :2700/3000/4000K
 Flux :630lm/960lm
 CRI :≥92
 Cutout :ø83mm

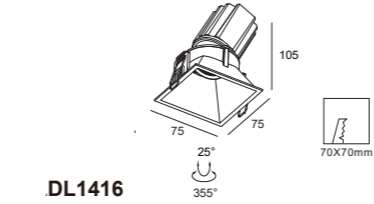
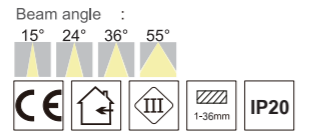

DL1416
 Power :1X7W/350mA/Max.19V
 1X10W/500mA/Max.19V
 CCT :2700/3000/4000K
 Flux :630lm/960lm
 CRI :≥92
 Cutout :70X70mm

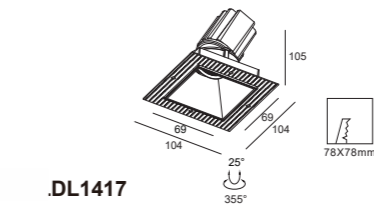
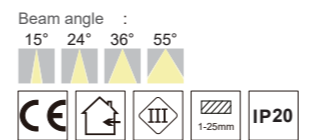

.DL1417
 Power :1X7W/350mA/Max.19V
 1X10W/500mA/Max.19V
 CCT :2700/3000/4000K
 Flux :630lm/960lm
 CRI :≥92
 Cutout :78X78mm

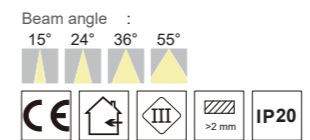

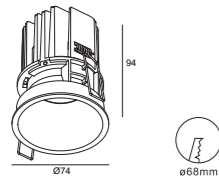
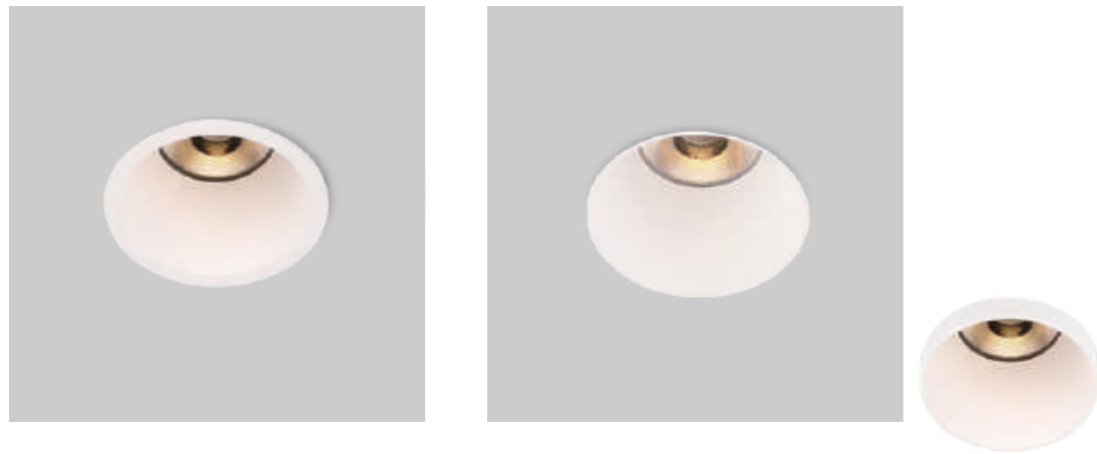

DL1121
 Power :1X10W/500mA/Max.19V
 CCT :2700/3000/4000K
 Flux :900lm
 CRI :≥92
 Cutout :ø68mm

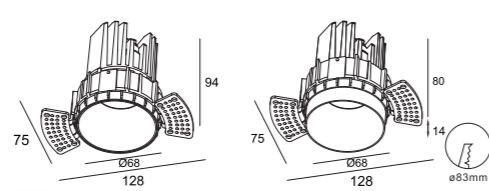
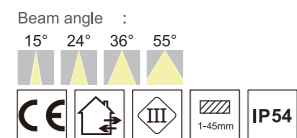

.DL1120
 Power :1X10W/500mA/Max.19V
 CCT :2700/3000/4000K
 Flux :900lm
 CRI :≥92
 Cutout :ø83mm

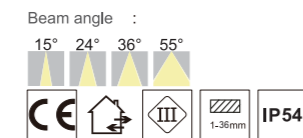

DL1062
 Power :1X13W/350mA/Max.37V
 CCT :2700/3000/4000K
 Flux :1180lm
 CRI :≥92
 Cutout :ø68mm

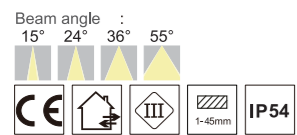

DL1000
 Power :1X13W/350mA/Max.37V
 CCT :2700/3000/4000K
 Flux :1180lm
 CRI :≥92
 Cutout :ø83mm

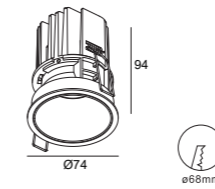
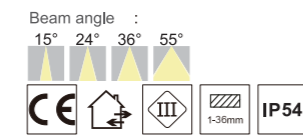

DL1296
 Power :1X10W/500mA/Max.19V
 CCT :2700/3000/4000K
 Flux :900lm
 CRI :≥92
 Cutout :ø68mm

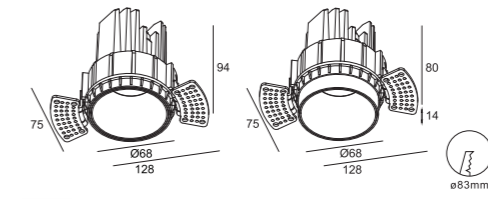
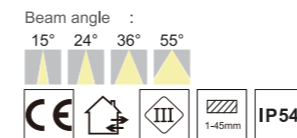

DL1297
 Power :1X10W/500mA/Max.19V
 CCT :2700/3000/4000K
 Flux :900lm
 CRI :≥92
 Cutout :ø83mm

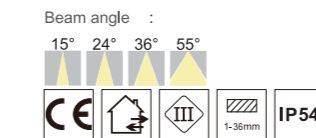

DL1162
 Power :1X13W/350mA/Max.37V
 CCT :2700/3000/4000K
 Flux :1180lm
 CRI :≥92
 Cutout :ø68mm

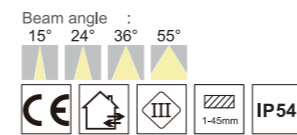

DL1163
 Power :1X13W/350mA/Max.37V
 CCT :2700/3000/4000K
 Flux :1180lm
 CRI :≥92
 Cutout :ø83mm

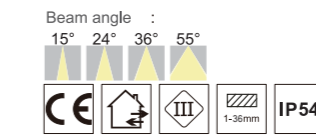

Reflector:



MOON

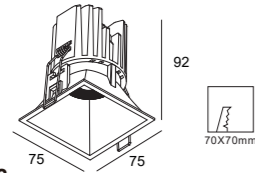
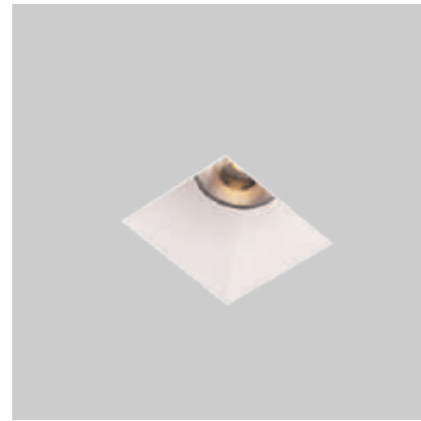
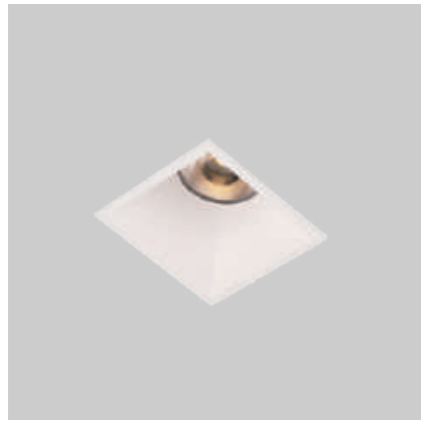

DL1102

Power :1X10W/500mA/Max.19V
 CCT :2700/3000/4000K
 Flux :900lm
 CRI :≥92
 Cutout :70*70mm

Beam angle :

15° 24° 36° 55°

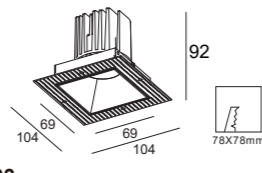

DL1103

Power :1X10W/500mA/Max.19V
 CCT :2700/3000/4000K
 Flux :900lm
 CRI :≥92
 Cutout :78*78mm

Beam angle :

15° 24° 36° 55°

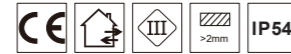

DL1104

Power :1X13W/350mA/Max.37V
 CCT :2700/3000/4000K
 Flux :1180lm
 CRI :≥92
 Cutout :70*70mm

Beam angle :

15° 24° 36° 55°

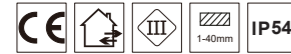

DL1105

Power :1X13W/350mA/Max.37V
 CCT :2700/3000/4000K
 Flux :1180lm
 CRI :≥92
 Cutout :78*78mm

Beam angle :

15° 24° 36° 55°



MOON

COLOR TW TB AB BC CP RG AG GL

LED CEILING RECESSED

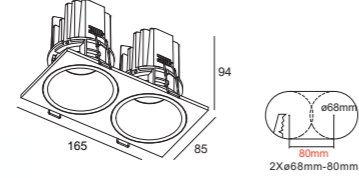
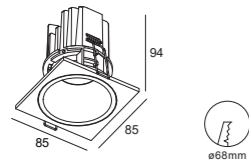
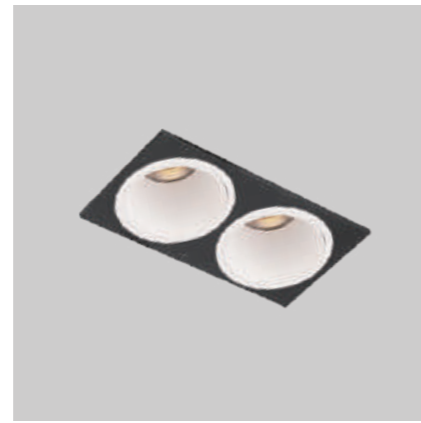
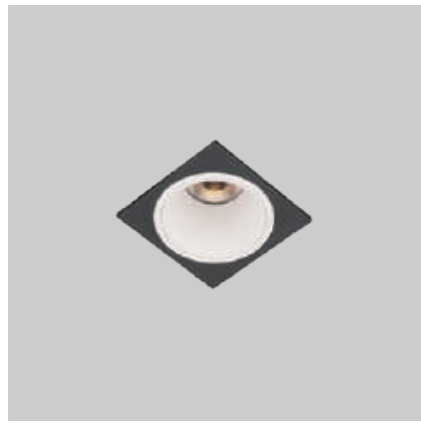

DL1255
 Power :1X10W/250mA/Max.37V
 :1X13W/350mA/Max.37V
 CCT :2700/3000/4000K
 Flux :960lm/1180lm
 CRI :≥92
 Cutout :ø68mm

DL1256
 Power :2X10W/250mA/2XMax.37V
 :2X13W/350mA/2XMax.37V
 CCT :2700/3000/4000K
 Flux :2X960lm/2X1180lm
 CRI :≥92
 Cutout :2Xø68-80mm

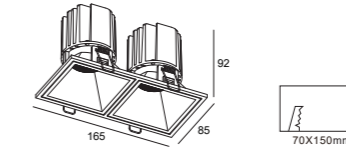
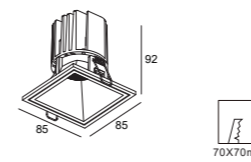
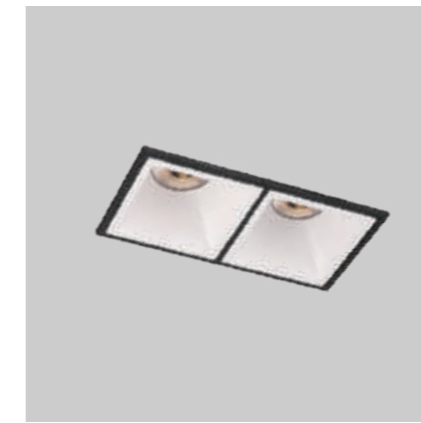
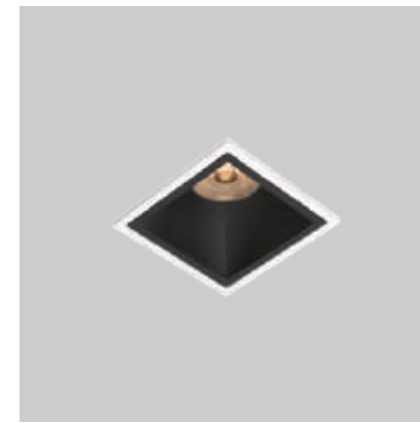
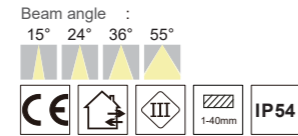
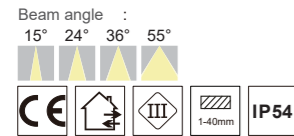

DL1253
 Power :1X10W/250mA/Max.37V
 :1X13W/350mA/Max.37V
 CCT :2700/3000/4000K
 Flux :960lm/1180lm
 CRI :≥92
 Cutout :70X70mm

DL1254
 Power :2X10W/250mA/2XMax.37V
 :2X13W/350mA/2XMax.37V
 CCT :2700/3000/4000K
 Flux :2X960lm/2X1180lm
 CRI :≥92
 Cutout :70X150mm

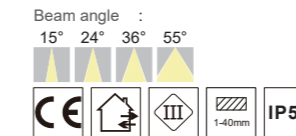
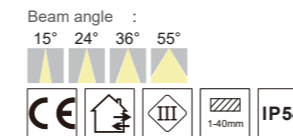

Reflector:



Choose the color you like to DIY !

MOON

COLOR TW TB

LED CEILING RECESSED

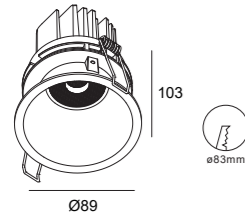

	Power	CCT	Flux	CRI	Cutout
DL1002	1X10W/500mA/Max.19V	2700/3000/4000K	960lm	≥92	ø83mm

DL1068	1X13W/350mA/Max.37V	2700/3000/4000K	1180lm	≥92	ø83mm
---------------	---------------------	-----------------	--------	-----	-------

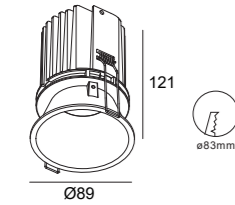
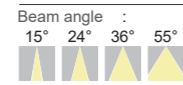

DL1463	1X18W/500mA/Max.37V	2700/3000/4000K	1620lm	≥92	ø83mm
---------------	---------------------	-----------------	--------	-----	-------

DL1464	1X26W/700mA/Max.37V	2700/3000/4000K	2600lm	≥92	ø83mm
---------------	---------------------	-----------------	--------	-----	-------

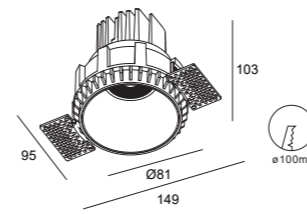
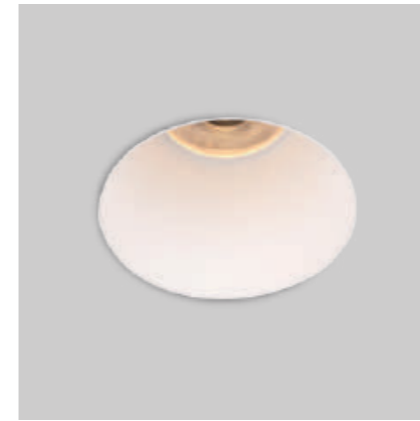
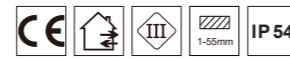
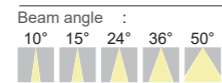

	Power	CCT	Flux	CRI	Cutout
DL1003	1X10W/500mA/Max.19V	2700/3000/4000K	960lm	≥92	ø100mm

DL1069	1X13W/350mA/Max.37V	2700/3000/4000K	1180lm	≥92	ø100mm
---------------	---------------------	-----------------	--------	-----	--------

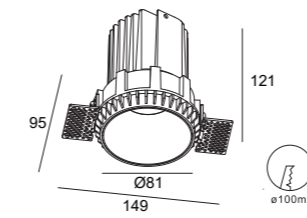
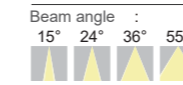

DL1136	1X18W/500mA/Max.37V	2700/3000/4000K	1620lm	≥92	ø100mm
---------------	---------------------	-----------------	--------	-----	--------

DL1359	1X26W/700mA/Max.37V	2700/3000/4000K	2600lm	≥92	ø100mm
---------------	---------------------	-----------------	--------	-----	--------

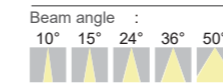

MOON

COLOR TW TB

LED CEILING RECESSED

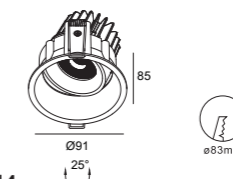
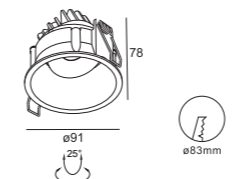
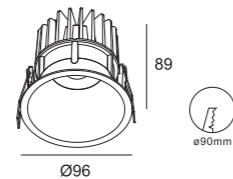
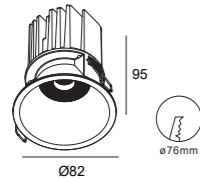

DL0997

Power :1X10W/500mA/Max.19V
 CCT :2700/3000/4000K
 Flux :900lm
 CRI :≥92/85
 Cutout :ø76mm

DL1131

Power :1X13W/350mA/Max.37V
 CCT :2700/3000/4000K
 Flux :1180lm
 CRI :≥92
 Cutout :ø90mm

DL0409

Power :7W/350mA/Max.19V
 CCT :2700/3000/4000K
 Flux :630lm
 CRI :≥92
 Cutout :ø83mm

.DL1014

Power :10W/500mA/Max.19V
 CCT :2700/3000/4000K
 Flux :630lm
 CRI :≥92
 Cutout :ø83mm

Beam angle :

15° 24° 36° 55°



Beam angle :

15° 24° 36° 55°



Beam angle :

24° 36° 60°



Beam angle :

15° 24° 36° 55°

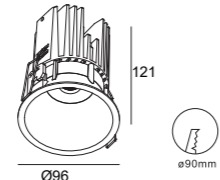
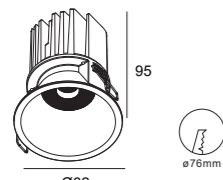

.DL1067

Power :1X13W/350mA/Max.37V
 CCT :2700/3000/4000K
 Flux :1180lm
 CRI :≥92
 Cutout :ø76mm

DL1133

Power :1X18W/500mA/Max.37V
 CCT :2700/3000/4000K
 Flux :1620lm
 CRI :≥92
 Cutout :ø90mm

Beam angle :

15° 24° 36° 55°



Beam angle :

10° 15° 24° 36° 50°



DL1357

Power :1X26W/700mA/Max.37V
 CCT :2700/3000/4000K
 Flux :2600lm
 CRI :≥92
 Cutout :ø90mm

Beam angle :

10° 15° 24° 36° 50°



MOON

COLOR TW TB

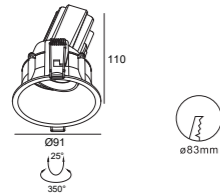
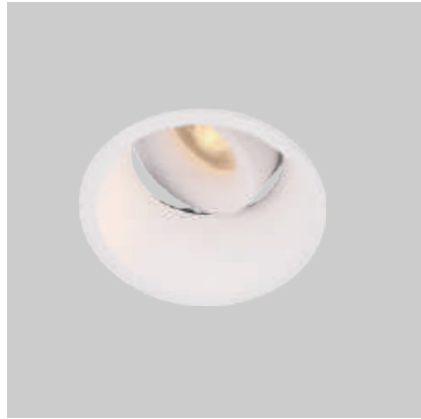

DL1191

Power :1X7W/350mA/Max.19V
:1X10W/500mA/Max.19V
CCT :2700/3000/4000K
Flux :630lm/960lm
CRI :≥92
Cutout :ø83mm

Beam angle :
10° 15° 24° 36° 50°

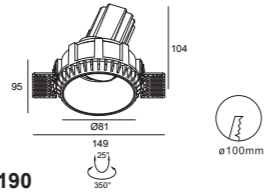

DL1190

Power :1X7W/350mA/Max.19V
:1X10W/500mA/Max.19V
CCT :2700/3000/4000K
Flux :630lm/960lm
CRI :≥92
Cutout :ø100mm

Beam angle :
10° 15° 24° 36° 50°

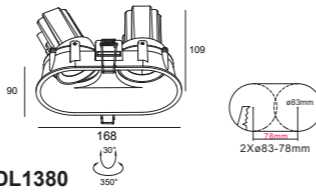

DL1380

Power :2X7W/350mA/Max.19V
:2X10W/500mA/Max.19V
CCT :2700/3000/4000K
Flux :630lm/960lm
CRI :≥92
Cutout :2Xø83-78mm

Beam angle :
10° 15° 24° 36° 50°

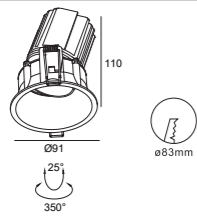

DL1192

Power :1X13W/350mA/Max.37V
CCT :2700/3000/4000K
Flux :1180lm
CRI :≥92
Cutout :ø83mm

Beam angle :
10° 15° 24° 36° 50°

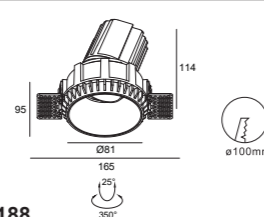
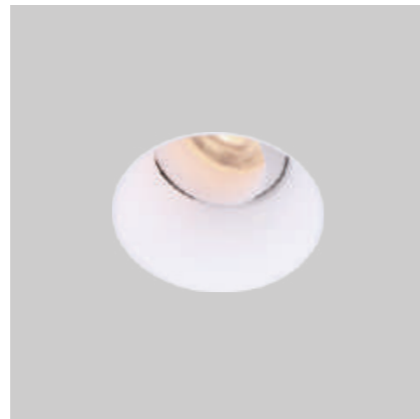

DL1188

Power :1X13W/350mA/Max.37V
CCT :2700/3000/4000K
Flux :1180lm
CRI :≥92
Cutout :ø100mm

Beam angle :
10° 15° 24° 36° 50°

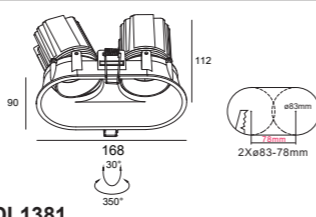

DL1381

Power :1X13W/350mA/Max.37V
CCT :2700/3000/4000K
Flux :1180lm
CRI :≥92
Cutout :2Xø83-78mm

Beam angle :
10° 15° 24° 36° 50°



MOON

COLOR TW TB

LED CEILING RECESSED

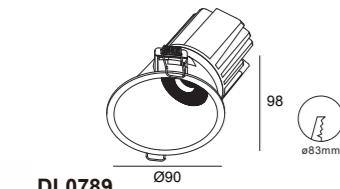
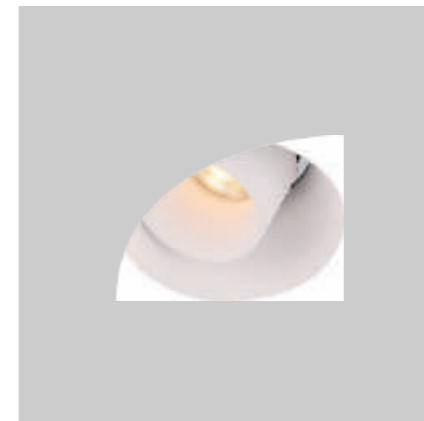
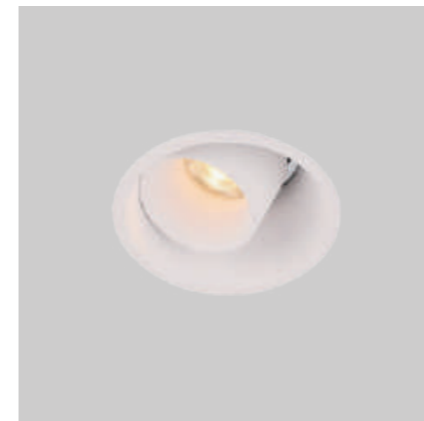
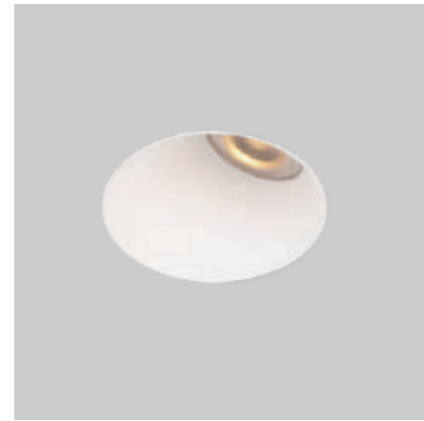

.DL0789
 Power :1X10W/500mA/Max.19V
 CCT :2700/3000/4000K
 Flux :800lm
 CRI :≥92/85
 Cutout :ø83mm

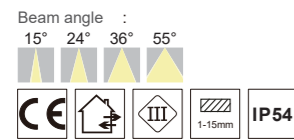

DL1074
 Power :1X13W/350mA/Max.37V
 CCT :2700/3000/4000K
 Flux :1040lm
 CRI :≥92/85
 Cutout :ø83mm

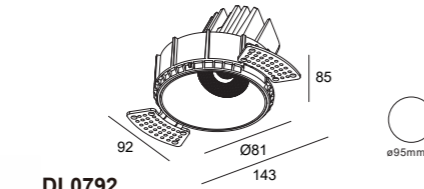
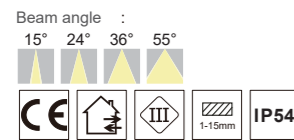

.DL0792
 Power :1X10W/500mA/Max.19V
 CCT :2700/3000/4000K
 Flux :800lm
 CRI :≥92/85
 Cutout :ø95mm

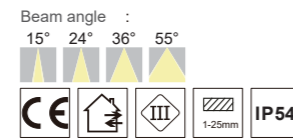

DL1075
 Power :1X13W/350mA/Max.37V
 CCT :2700/3000/4000K
 Flux :1040lm
 CRI :≥92
 Cutout :ø95mm

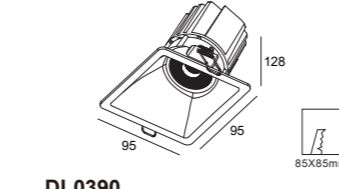
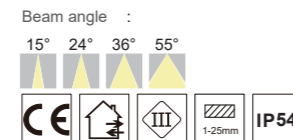

.DL0390
 Power :1X13W/350mA/Max.37V
 CCT :2700/3000/4000K
 Flux :1020lm
 CRI :≥92
 Cutout :85X85mm

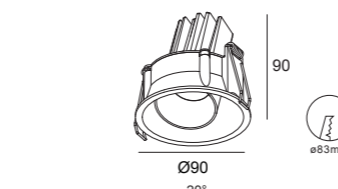
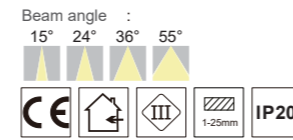

.DL1305
 Power :1X7W/350mA/Max.19V
 :1X10W/500mA/Max.19V
 CCT :2700/3000/4000K
 Flux :630lm/960lm
 CRI :≥92
 Cutout :ø83mm

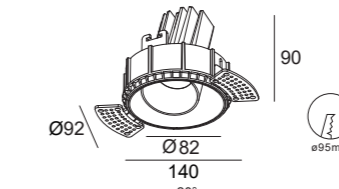
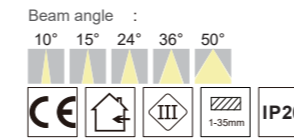

DL1306
 Power :1X7W/350mA/Max.19V
 :1X10W/500mA/Max.19V
 CCT :2700/3000/4000K
 Flux :630lm/960lm
 CRI :≥92
 Cutout :ø95mm

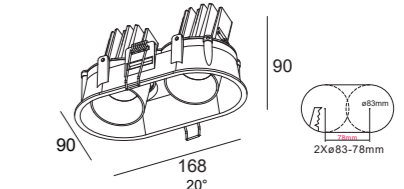
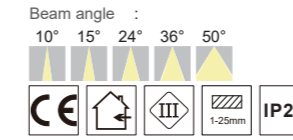

.DL1307
 Power :2X7W/350mA/2XMax.19V
 :2X10W/500mA/2XMax.19V
 CCT :2700/3000/4000K
 Flux :2X630lm/2X960lm
 CRI :≥92
 Cutout :2Xø83-78mm

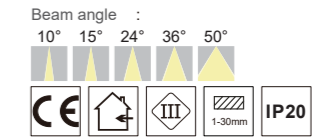

MOON

COLOR TW TB

LED CEILING RECESSED

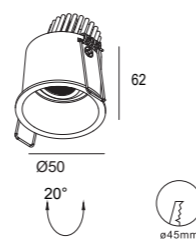
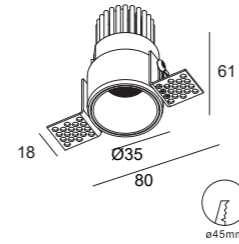
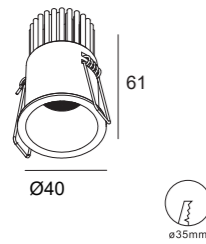
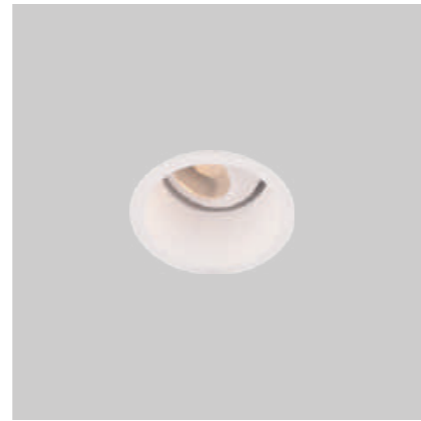
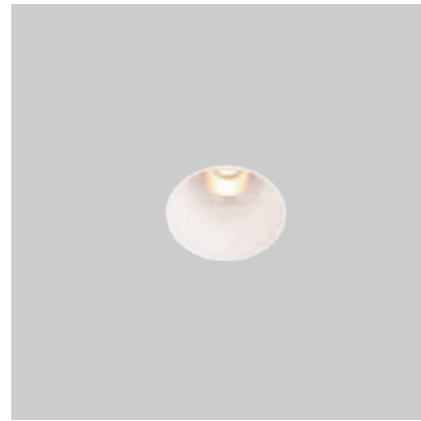
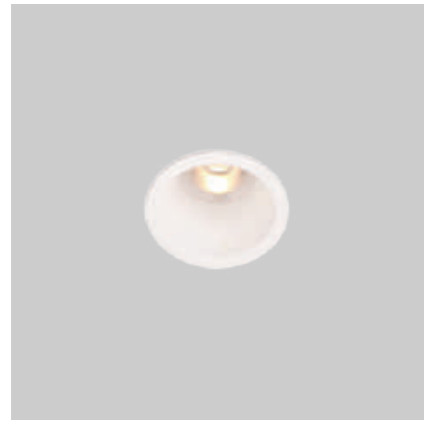

DL1225
 Power :1X5W/500mA/Max.10V
 CCT :2700/3000/4000K
 Flux :450lm
 CRI :≥92
 Cutout :ø35mm

DL1226
 Power :1X5W/500mA/Max.10V
 CCT :2700/3000/4000K
 Flux :450lm
 CRI :≥92
 Cuout :ø45mm

DL1227
 Power :1X5W/500mA/Max.10V
 CCT :2700/3000/4000K
 Flux :450lm
 CRI :≥92
 Cutout :ø45mm

Beam angle :
 15° 24° 36° 55°

CE, Home, III, 1-24mm, IP20

Beam angle :
 15° 24° 36° 55°

CE, Home, III, 1-25mm, IP20

Beam angle :
 15° 24° 36° 55°

CE, Home, III, 1-30mm, IP20



MOON

COLOR TW TB AB BC CP RG AG GL

LED CEILING RECESSED

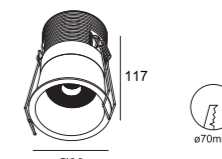
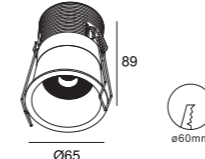
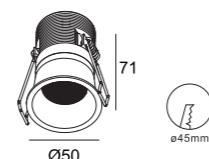
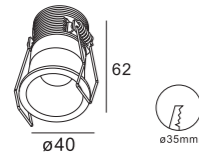
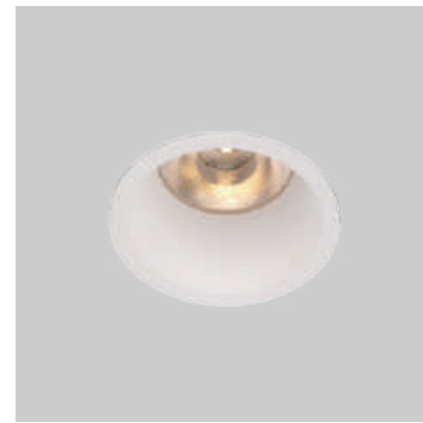

DL0962

Power :1X5W/500mA/Max.10V
 CCT :2700/3000/4000K
 Flux :450lm
 CRI :≥92
 Cutout :ø35mm

DL1025

Power :1X7W/350mA/Max.19V
 CCT :2700/3000/4000K
 Flux :630lm
 CRI :≥92
 Cutout :ø45mm

DL1026:1X10W/500mA/Max.19V
DL1369:1X13W/350mA/Max.37V
 CCT :2700/3000/4000K
 Flux :960lm/1180lm
 CRI :≥92
 Cutout :ø60mm

DL1027

Power :1X18W/500mA/Max.37V
 CCT :2700/3000/4000K
 Flux :1620lm
 CRI :≥92
 Cutout :ø70mm

Beam angle :
 10° 15° 24° 36° 50°



Beam angle :
 15° 24° 36° 55°



Beam angle :
 15° 24° 36° 55°



Beam angle :
 15° 24° 36° 55°

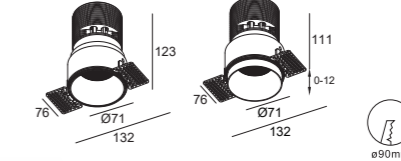
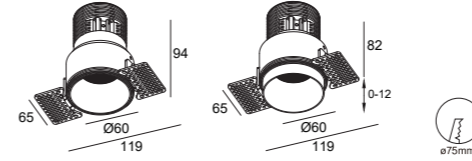
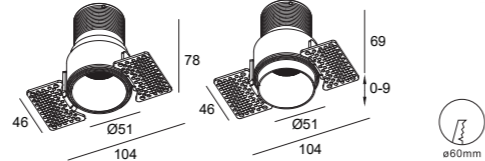
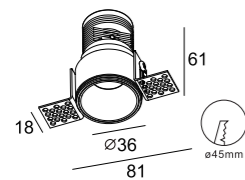
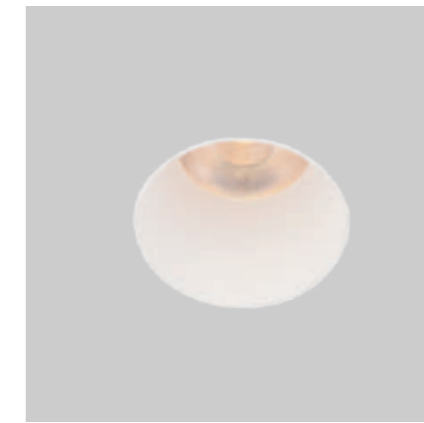
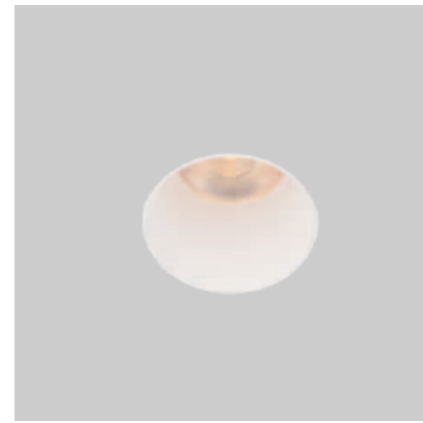
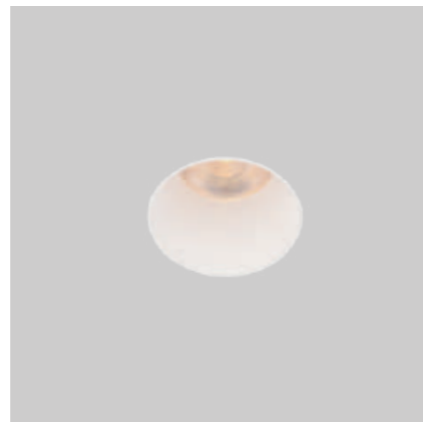

DL1169

Power :1X5W/500mA/Max.10V
 CCT :2700/3000/4000K
 Flux :450lm
 CRI :≥92
 Cutout :ø45mm

DL1184

Power :1X7W/350mA/Max.19V
 CCT :2700/3000/4000K
 Flux :630lm
 CRI :≥92/85
 Cutout :ø60mm

DL1175:1X10W/500mA/Max.19V
DL1371:1X13W/350mA/Max.37V
 CCT :2700/3000/4000K
 Flux :900lm/1180lm
 CRI :≥92
 Cutout :ø75mm

DL1176

Power :1X18W/500mA/Max.37V
 CCT :2700/3000/4000K
 Flux :1620lm
 CRI :≥92
 Cutout :ø90mm

Beam angle :
 10° 15° 24° 36° 50°



Beam angle :
 15° 24° 36° 55°



Beam angle :
 15° 24° 36° 55°



Beam angle :
 15° 24° 36° 55°



MOON

COLOR TW TB AB BC CP RG AG GL

LED CEILING RECESSED

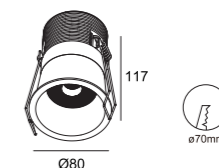
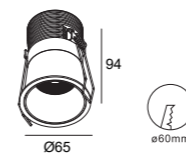
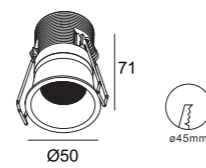
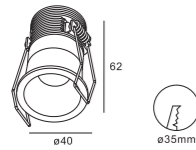
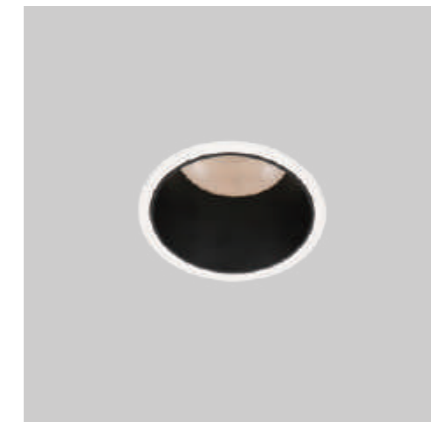
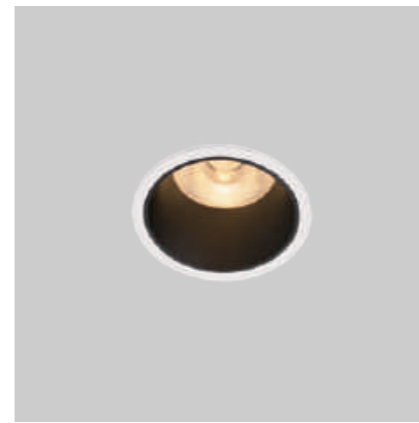
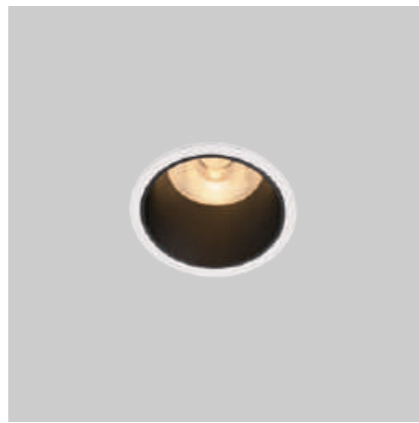
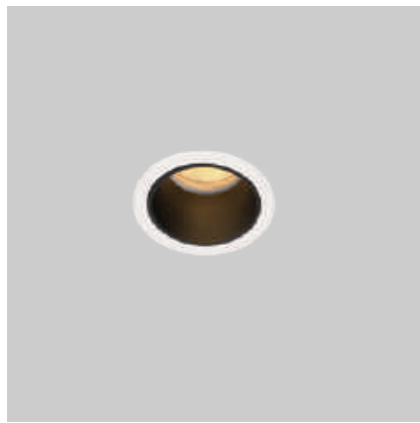

DL1181

Power :1X5W/500mA/Max.10V
CCT :2700/3000/4000K
Flux :450lm
CRI :≥92
Cutout :ø35mm

DL1186

Power :1X7W/350mA/Max.19V
CCT :2700/3000/4000K
Flux :630lm
CRI :≥92
Cutout :ø45mm

DL1165:1X10W/500mA/Max.19V
DL1370:1X13W/350mA/Max.37V
CCT :2700/3000/4000K
Flux :900lm/1180lm
CRI :≥92
Cutout :ø60mm

DL1178

Power :1X18W/500mA/Max.37V
CCT :2700/3000/4000K
Flux :1620lm
CRI :≥92
Cutout :ø70mm

Beam angle :
10° 15° 24° 36° 50°



Beam angle :
15° 24° 36° 55°



Beam angle :
15° 24° 36° 55°



Beam angle :
15° 24° 36° 55°

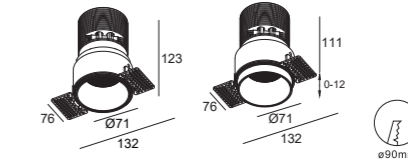
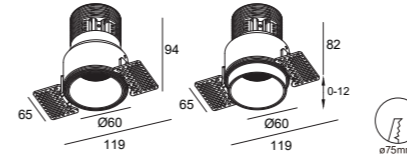
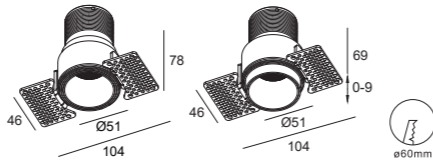
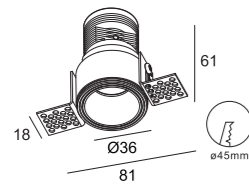
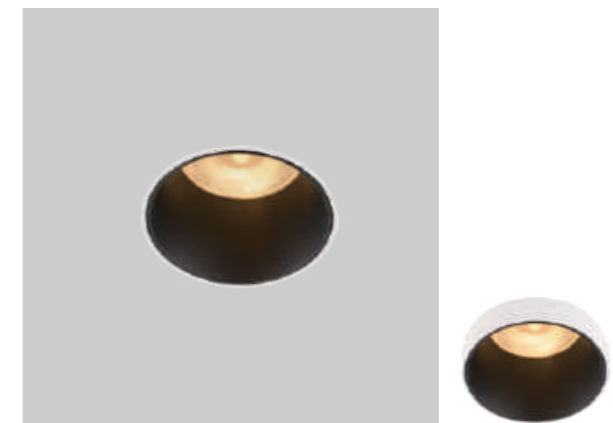

DL1210

Power :1X5W/500mA/Max.10V
CCT :2700/3000/4000K
Flux :450lm
CRI :≥92
Cutout :ø45mm

.DL1185

Power :1X7W/350mA/Max.19V
CCT :2700/3000/4000K
Flux :630lm
CRI :≥92
Cutout :ø60mm

DL1166:1X10W/500mA/Max.19V
DL1372:1X13W/350mA/Max.37V
CCT :2700/3000/4000K
Flux :900lm/1180lm
CRI :≥92
Cutout :ø75mm

DL1177

Power :1X18W/500mA/Max.37V
CCT :2700/3000/4000K
Flux :1620lm
CRI :≥92
Cutout :ø90mm

Beam angle :
10° 15° 24° 36° 50°



Beam angle :
15° 24° 36° 55°



Beam angle :
15° 24° 36° 55°



Beam angle :
15° 24° 36° 55°



MOON-Outdoor

COLOR TW TB

LED CEILING RECESSED

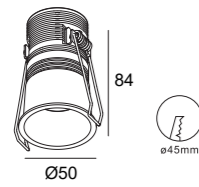
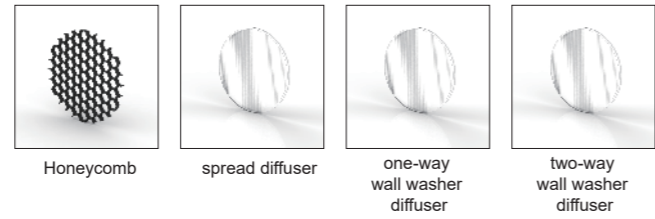
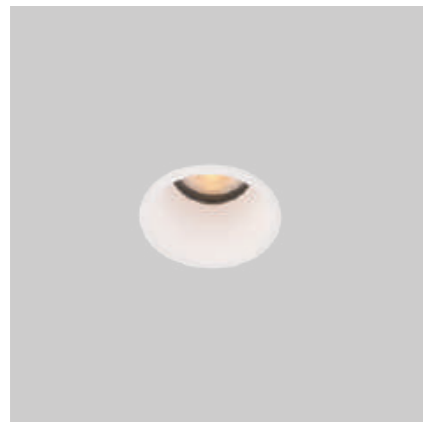

DL1233

Power :1X7W/350mA/Max.19V
 CCT :2700/3000/4000K
 Flux :630lm
 CRI :≥92
 Cutout :ø45mm

Beam angle :
 15° 24° 36° 55°

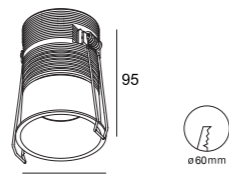

DL1239

Power :1X10W/500mA/Max.19V
 CCT :2700/3000/4000K
 Flux :960lm
 CRI :≥92
 Cuout :ø60mm

Beam angle :
 15° 24° 36° 55°

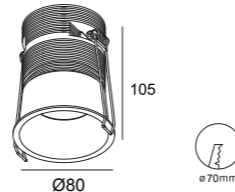

DL1245

Power :1X13W/350mA/Max.37V
 CCT :2700/3000/4000K
 Flux :1170lm/1800lm
 CRI :≥92
 Cutout :ø70mm

Beam angle :
 15° 24° 36° 55°

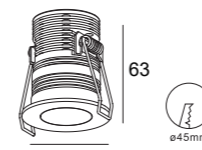
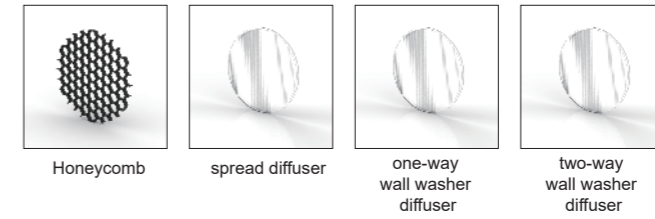

DL1230

Power :1X7W/350mA/Max.19V
 CCT :2700/3000/4000K
 Flux :630lm
 CRI :≥92
 Cutout :ø45mm

Beam angle :
 15° 24° 36° 55°

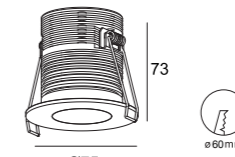

DL1236

Power :1X10W/500mA/Max.19V
 CCT :2700/3000/4000K
 Flux :960lm
 CRI :≥92
 Cuout :ø60mm

Beam angle :
 15° 24° 36° 55°

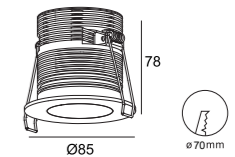

DL1242

Power :1X13W/350mA/Max.37V
 CCT :2700/3000/4000K
 Flux :1170lm/1800lm
 CRI :≥92
 Cutout :ø70mm

Beam angle :
 15° 24° 36° 55°

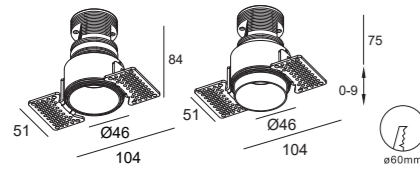
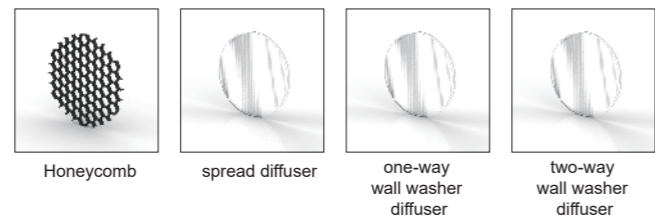
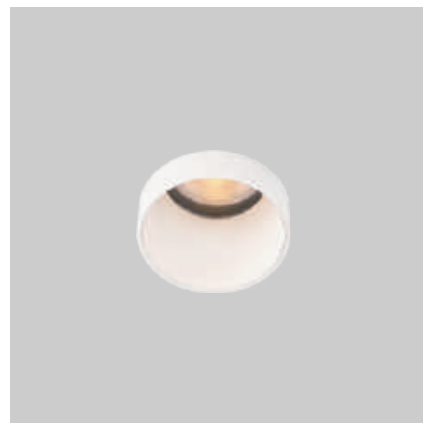

DL1232

Power :1X7W/350mA/Max.19V
 CCT :2700/3000/4000K
 Flux :630lm
 CRI :≥92
 Cutout :ø60mm

Beam angle :
 15° 24° 36° 55°

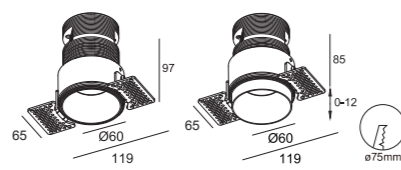

DL1238

Power :1X10W/500mA/Max.19V
 CCT :2700/3000/4000K
 Flux :960lm
 CRI :≥92
 Cuout :ø75mm

Beam angle :
 15° 24° 36° 55°

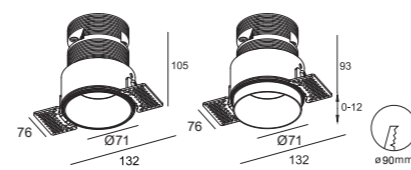

DL1244

Power :1X13W/350mA/Max.37V
 CCT :2700/3000/4000K
 Flux :1170lm/1800lm
 CRI :≥92
 Cutout :ø90mm

Beam angle :
 15° 24° 36° 55°

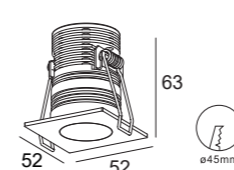
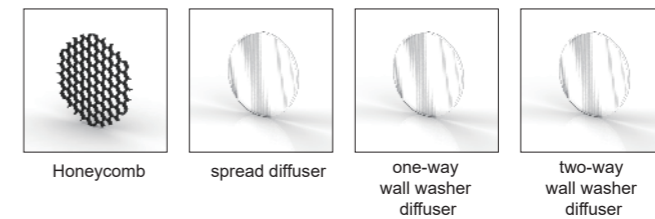

DL1231

Power :1X7W/350mA/Max.19V
 CCT :2700/3000/4000K
 Flux :630lm
 CRI :≥92
 Cutout :ø45mm

Beam angle :
 15° 24° 36° 55°

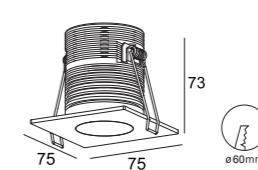

DL1237

Power :1X10W/500mA/Max.19V
 CCT :2700/3000/4000K
 Flux :960lm
 CRI :≥92
 Cuout :ø60mm

Beam angle :
 15° 24° 36° 55°

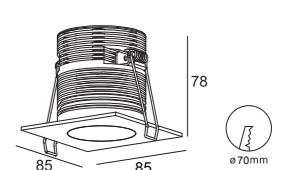

DL1243

Power :1X13W/350mA/Max.37V
 CCT :2700/3000/4000K
 Flux :1170lm/1800lm
 CRI :≥92
 Cutout :ø70mm

Beam angle :
 15° 24° 36° 55°



FORT

COLOR: TW TB

LED CEILING RECESSED

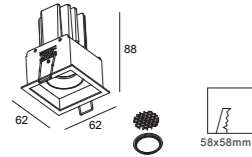
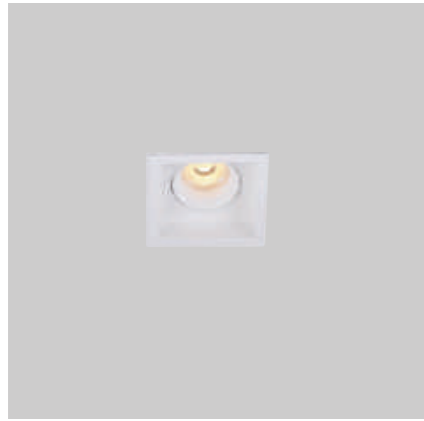

DL1286

Power :7W/350mA/Max.19V
:10W/500mA/Max.19V
CCT :2700/3000/4000K
Flux :630lm/960lm
CRI :≥92
Cutout :58x58mm

Beam angle :
15° 24° 36° 55°

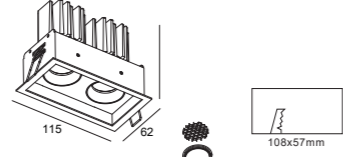
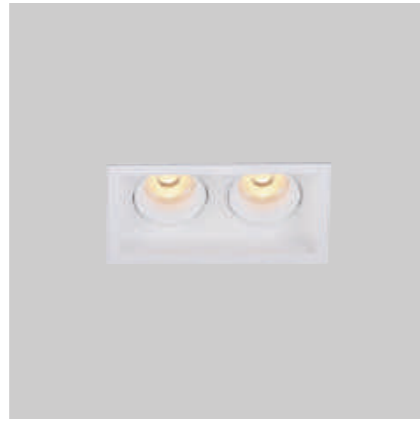

DL1287

Power :2X7W/350mA/2XMax.19V
:2X10W/500mA/2XMax.19V
CCT :2700/3000/4000K
Flux :2X630lm/2X960lm
CRI :≥92
Cutout :108x57mm

Beam angle :
15° 24° 36° 55°

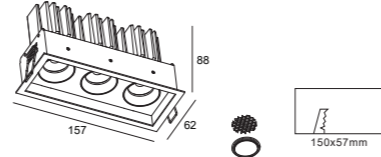

DL1288

Power :3X7W/350mA/3XMax.19V
:3X10W/500mA/3XMax.19V
CCT :2700/3000/4000K
Flux :3X630lm/3X960lm
CRI :≥92
Cutout :150x57mm

Beam angle :
15° 24° 36° 55°

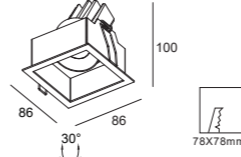

DL1498

Power :1X7W/350mA/Max.19V
:1X10W/500mA/Max.19V
CCT :2700/3000/4000K
Flux :630lm
CRI :≥92
Cutout :78X78mm

Beam angle :
15° 24° 36° 60°

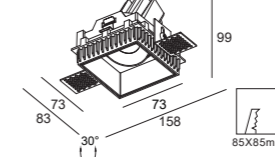
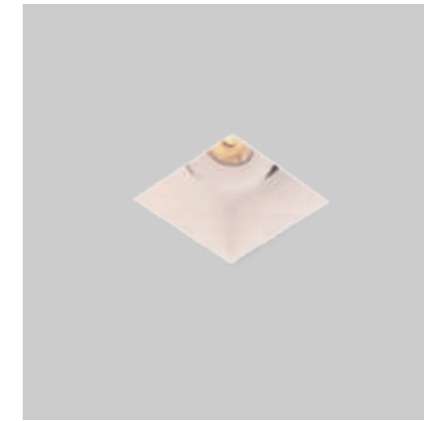

DL1499

Power :1X7W/350mA/Max.19V
:1X10W/500mA/Max.19V
CCT :2700/3000/4000K
Flux :630lm
CRI :≥92
Cutout :85X85mm

Beam angle :
15° 24° 36° 60°

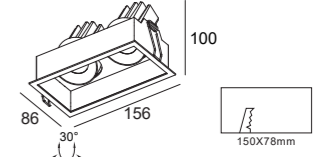

DL1500

Power :2X7W/350mA/2XMax.19V
:2X10W/500mA/2XMax.19V
CCT :2700/3000/4000K
Flux :2X630lm
CRI :≥92
Cutout :150X78mm

Beam angle :
15° 24° 36° 60°



FORT

COLOR: TW TB

LED CEILING RECESSED

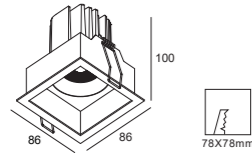
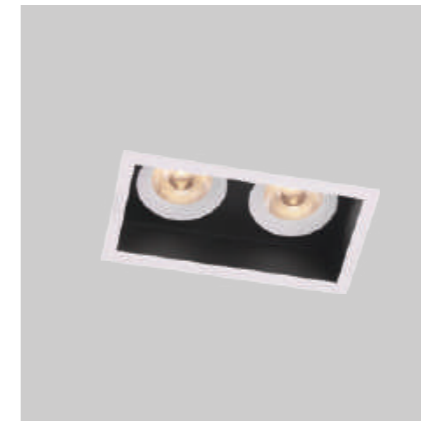
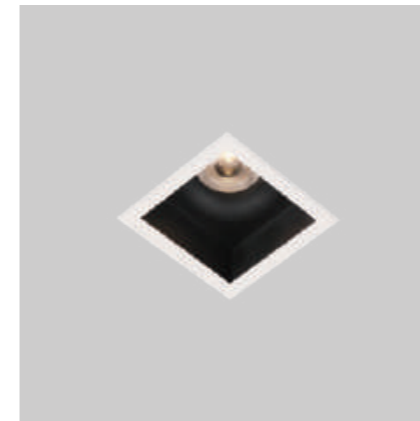
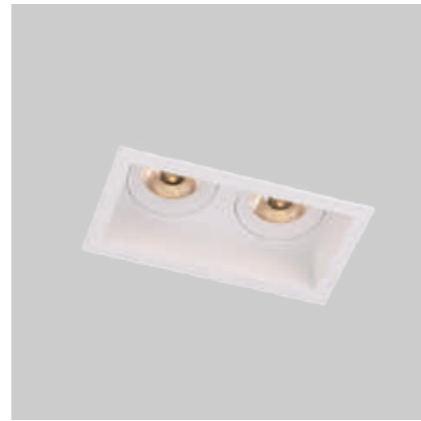

DL1004

Power :1X10W/500mA/Max.19V
 CCT :2700/3000/4000K
 Flux :900lm
 CRI :≥92
 Cutout :78X78mm

Beam angle :
 15° 24° 36° 55°

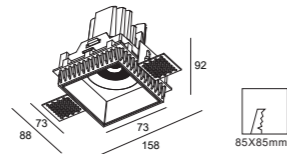

DL1031

Power :1X10W/500mA/Max.19V
 CCT :2700/3000/4000K
 Flux :900lm
 CRI :≥92
 Cutout :85X85mm

Beam angle :
 15° 24° 36° 55°

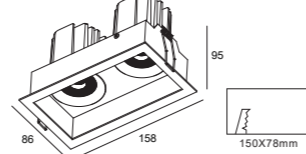

DL1053

Power :2X10W/500mA/2XMax.19V
 CCT :2700/3000/4000K
 Flux :2X900lm
 CRI :≥92
 Cutout :150X78mm

Beam angle :
 15° 24° 36° 55°

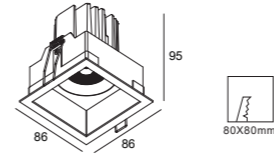

DL1052

Power :1X10W/500mA/Max.19V
 CCT :2700/3000/4000K
 Flux :900lm
 CRI :≥92
 Cutout :80X80mm

Beam angle :
 15° 24° 36° 55°

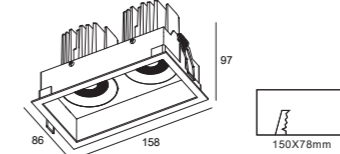

DL1054

Power :2X10W/500mA/2XMax.19V
 CCT :2700/3000/4000K
 Flux :2X900lm
 CRI :≥92
 Cutout :150X78mm

Beam angle :
 15° 24° 36° 55°



DL1076

Power :1X13W/350mA/Max.37V
 CCT :2700/3000/4000K
 Flux :1180lm
 CRI :≥92
 Cutout :78X78mm

Beam angle :
 15° 24° 36° 55°



DL1077

Power :1X13W/350mA/Max.37V
 CCT :2700/3000/4000K
 Flux :1180lm
 CRI :≥92
 Cutout :85X85mm

Beam angle :
 15° 24° 36° 55°



DL1079

Power :2X13W/350mA/2XMax.37V
 CCT :2700/3000/4000K
 Flux :2X1180lm
 CRI :≥92
 Cutout :150X78mm

Beam angle :
 15° 24° 36° 55°



DL1078

Power :1X13W/350mA/Max.37V
 CCT :2700/3000/4000K
 Flux :1250lm
 CRI :≥92
 Cutout :80X80mm

Beam angle :
 15° 24° 36° 55°



DL1080

Power :2X13W/350mA/2XMax.37V
 CCT :2700/3000/4000K
 Flux :2X1250lm
 CRI :≥92
 Cutout :150X78mm

Beam angle :
 15° 24° 36° 55°



FORT

COLOR: TW TB

LED CEILING RECESSED

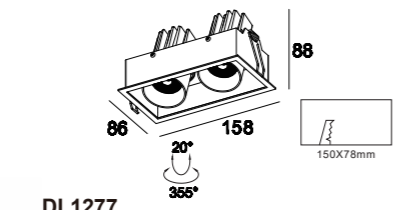
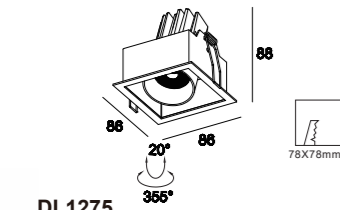

DL1275
 Power :1X7W/350mA/Max.19V
 :1X10W/500mA/Max.19V
 CCT :2700/3000/4000K
 Flux :630lm/960lm
 CRI :≥92
 Cutout :78X78mm

DL1277
 Power :2X7W/350mA/2XMax.19V
 :2X10W/500mA/2XMax.19V
 CCT :2700/3000/4000K
 Flux :2X630lm/2X960lm
 CRI :≥92
 Cutout :150X78mm

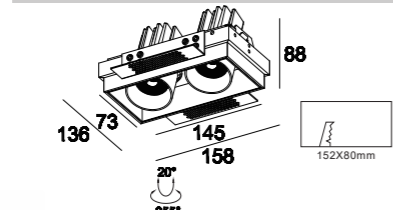
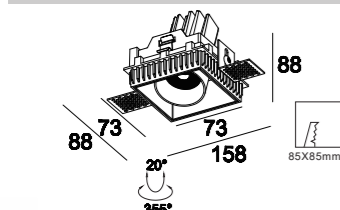
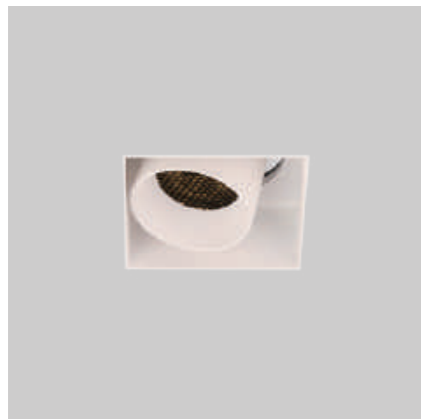
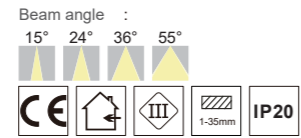
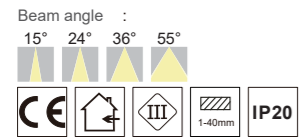

DL1276
 Power :1X7W/350mA/Max.19V
 :1X10W/500mA/Max.19V
 CCT :2700/3000/4000K
 Flux :630lm/960lm
 CRI :≥92
 Cutout :85X85mm

DL1278
 Power :2X7W/350mA/2XMax.19V
 :2X10W/500mA/2XMax.19V
 CCT :2700/3000/4000K
 Flux :2X630lm/2X960lm
 CRI :≥92
 Cutout :150X78mm

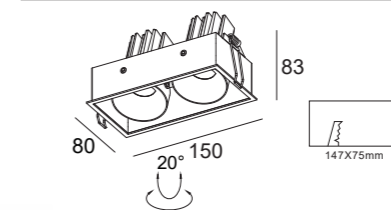
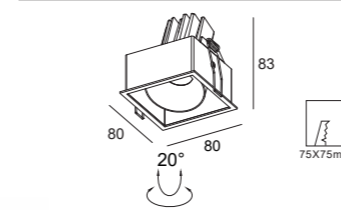
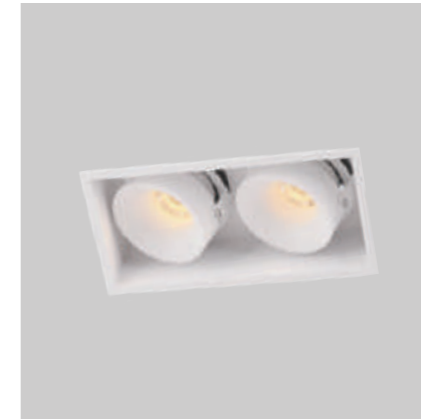
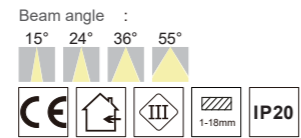
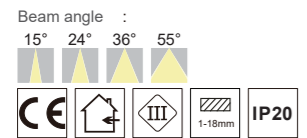

DL1454
 Power :1X7W/350mA/Max.19V
 :1X10W/500mA/Max.19V
 CCT :2700/3000/4000K
 Flux :630lm/960lm
 CRI :≥92
 Cutout :75X75mm

DL1455
 Power :2X7W/350mA/2XMax.19V
 :2X10W/500mA/2XMax.19V
 CCT :2700/3000/4000K
 Flux :2X630lm/2X960lm
 CRI :≥92
 Cutout :147X75mm

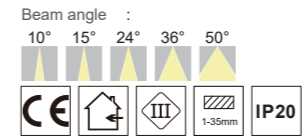
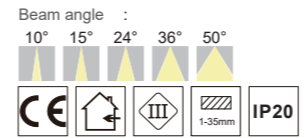

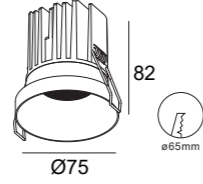
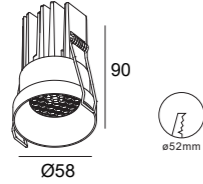

DL1385

Power :1X7W/350mA/Max.19V
1X10W/500mA/Max.19V
CCT :2700/3000/4000K
Flux :630lm/960lm
CRI :≥92
Cutout :ø52mm

Beam angle :
15° 24° 36° 55°



DL1174

Power :1X13W/350mA/Max.37V
CCT :2700/3000/4000K
Flux :1180lm
CRI :≥92
Cutout :ø65mm

Beam angle :
15° 24° 36° 55°

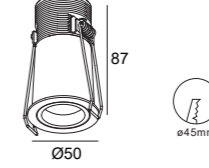
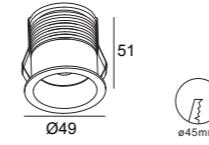
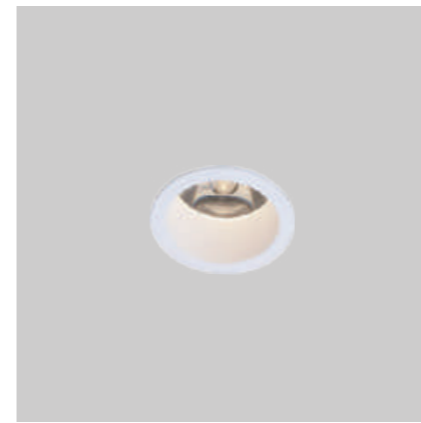

DL1452

Power :1X2W/700mA/Max.3V
CCT :2700/3000/4000K
Flux :160lm
CRI :≥92
Cutout :ø45mm

Beam angle :
3°



DL1441

Power :1X7W/350mA/Max.19V
CCT :2700/3000/4000K
Flux :500lm
CRI :≥92
Cutout :ø45mm

Beam angle :
3°



VERO

COLOR: TW TB

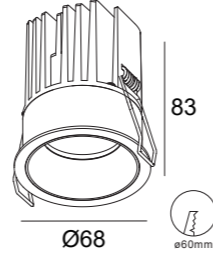
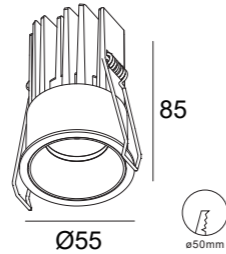
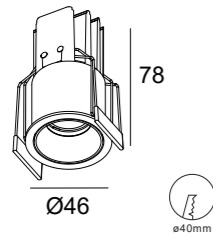
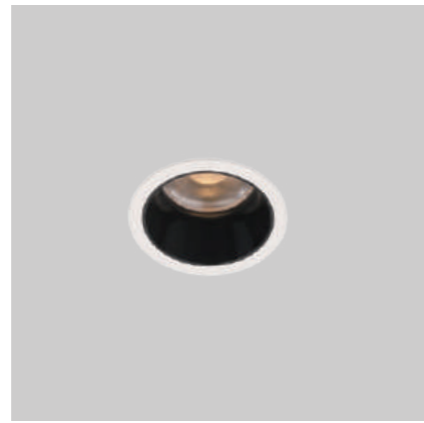
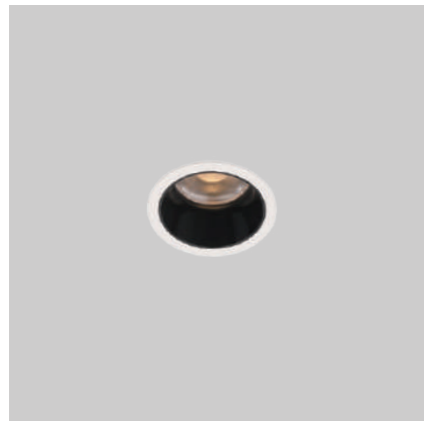

.DL1222
 Power :1X7W/350mA/Max.19V
 CCT :2700/3000/4000K
 Flux :630lm
 CRI :≥92
 Cutout :ø40mm

DL1223
 Power :1X10W/500mA/Max.19V
 CCT :2700/3000/4000K
 Flux :630lm/960lm
 CRI :≥92
 Cuout :ø53mm

DL1224
 Power :1X13W/350mA/Max.37V
 CCT :2700/3000/4000K
 Flux :1170lm
 CRI :≥92
 Cutout :ø60mm

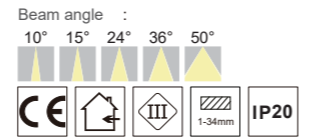
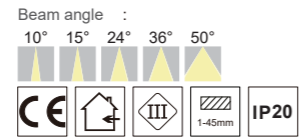
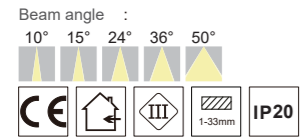

Accessories:

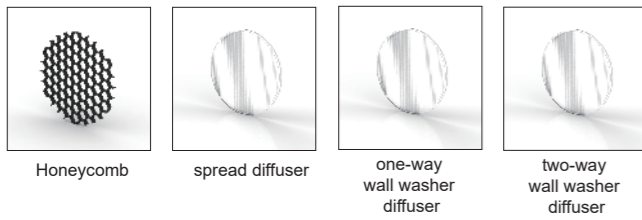

Reflector:



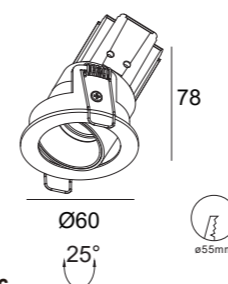
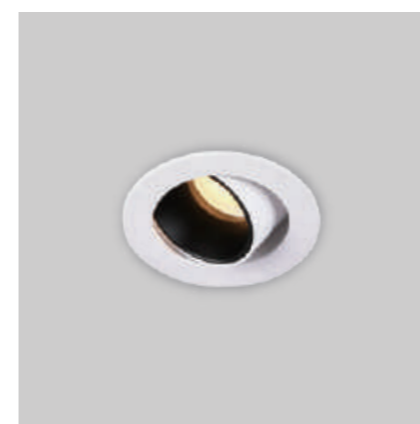

DL1446

Power :1X7W/350mA/Max.19V
 CCT :2700/3000/4000K
 Flux :630lm
 CRI :≥92
 Cotout :ø55mm

Beam angle :
 10° 15° 24° 36° 50°

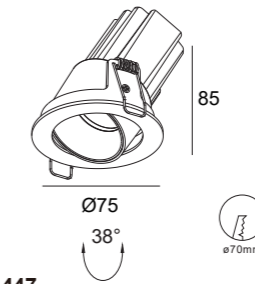
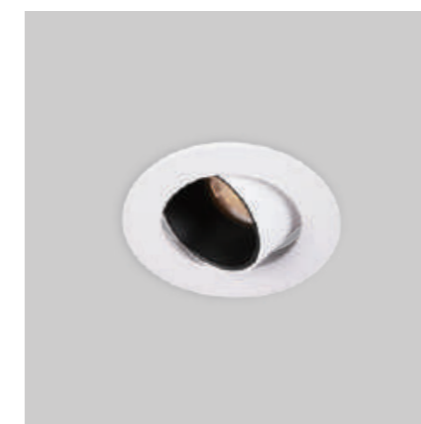

DL1447

Power :1X7W/350mA/Max.19V
 1X10W/500mA/Max.19V
 CCT :2700/3000/4000K
 Flux :630ml/960lm
 CRI :≥92
 Cotout :ø70mm

Beam angle :
 10° 15° 24° 36° 50°

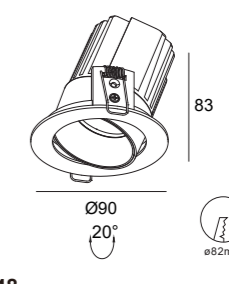

DL1448

Power :1X13W/350mA/Max.37V
 CCT :2700/3000/4000K
 Flux :1170lm
 CRI :≥92
 Cotout :ø82mm

Beam angle :
 10° 15° 24° 36° 50°



Accessories:

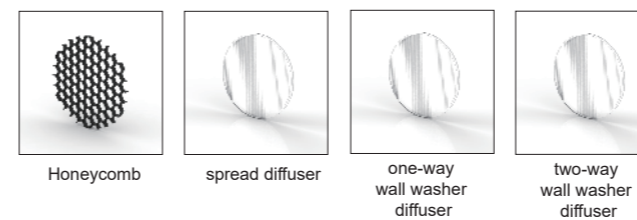

Reflector:



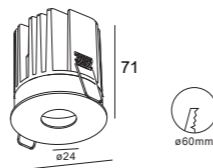
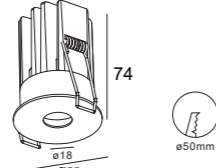
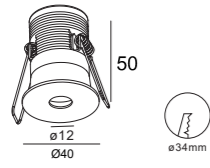
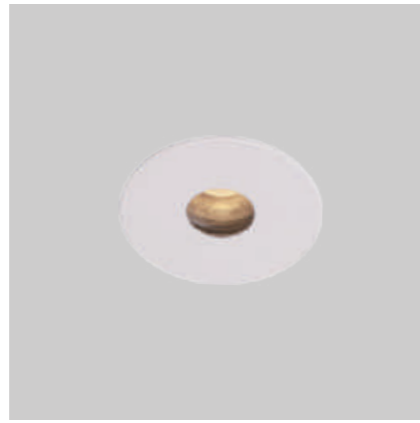
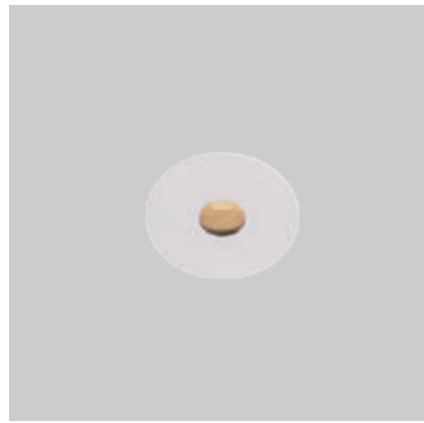

DL1423
 Power :1X5W/500mA/Max.10V
 CCT :2700/3000/4000K
 Flux :400lm
 CRI :≥92
 Cutout :ø34mm

DL1424
 Power :1X7W/350mA/Max.19V
 1X10W/500mA/Max.19V
 CCT :2700/3000/4000K
 Flux :560lm/780lm
 CRI :≥92
 Cutout :ø50mm

DL1425
 Power :1X13W/350mA/Max.37V
 CCT :2700/3000/4000K
 Flux :1080lm
 CRI :≥92
 Cuout :ø60mm

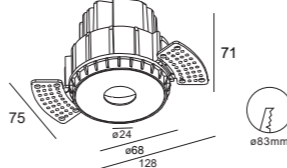
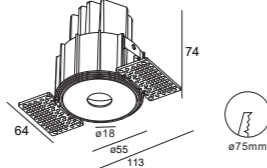
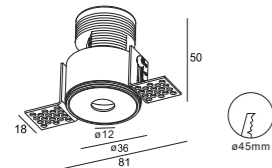
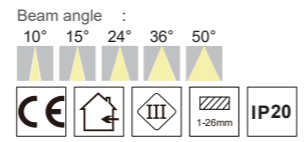
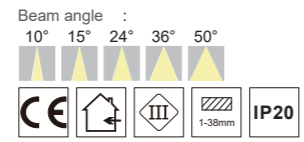
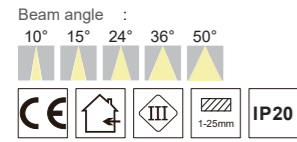

DL1437
 Power :1X5W/500mA/Max.10V
 CCT :2700/3000/4000K
 Flux :400lm
 CRI :≥92
 Cutout :ø45mm

DL1438
 Power :1X7W/350mA/Max.19V
 1X10W/500mA/Max.19V
 CCT :2700/3000/4000K
 Flux :560lm/780lm
 CRI :≥92
 Cutout :ø75mm

DL1439
 Power :1X13W/350mA/Max.37V
 CCT :2700/3000/4000K
 Flux :1080lm
 CRI :≥92
 Cuout :ø83mm

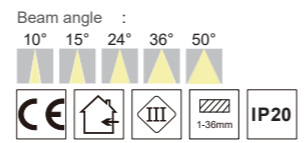
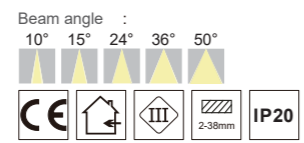
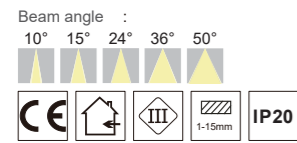

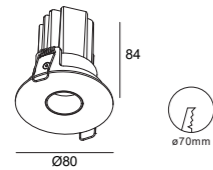
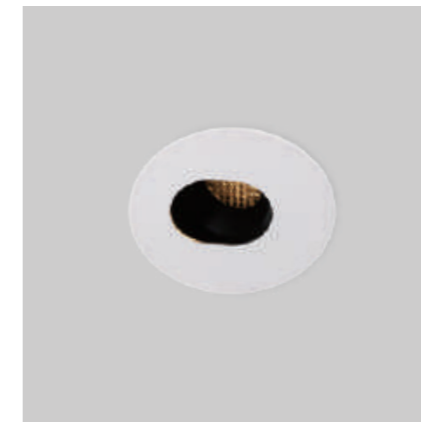
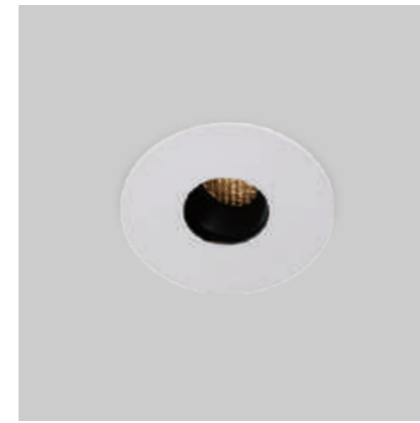
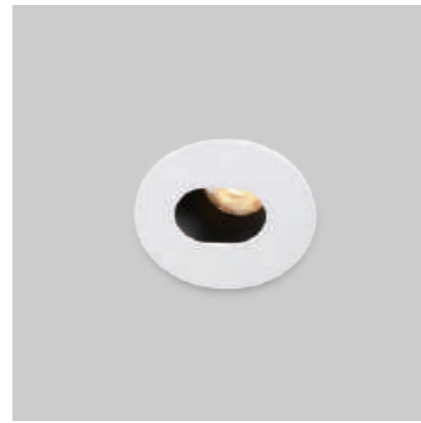
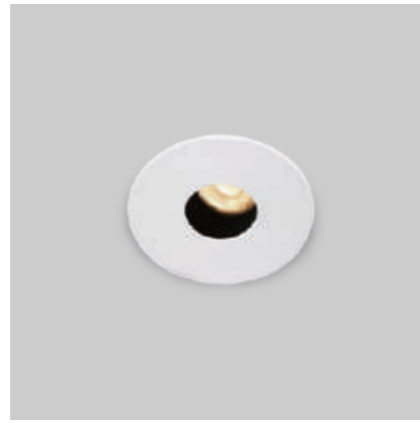
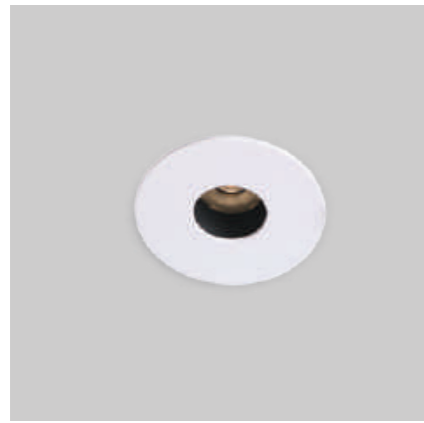

DL1412
 Power :1X7W/350mA/Max.19V
 :1X10W/500mA/Max.19V
 CCT :2700/3000/4000K
 Flux :560lm/860lm
 CRI :≥92/85
 Cotout :ø70mm

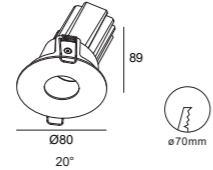
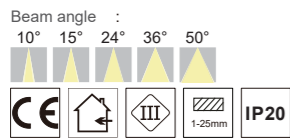

DL1413
 Power :1X7W/350mA/Max.19V
 :1X10W/500mA/Max.19V
 CCT :2700/3000/4000K
 Flux :560lm/860lm
 CRI :≥92/85
 Cotout :ø70mm

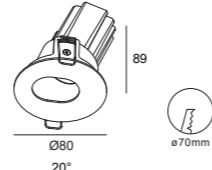
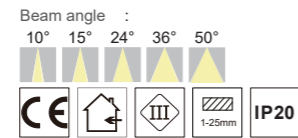

DL1411
 Power :1X7W/350mA/Max.19V
 :1X10W/500mA/Max.19V
 CCT :2700/3000/4000K
 Flux :560lm/860lm
 CRI :≥92/85
 Cotout :ø70mm

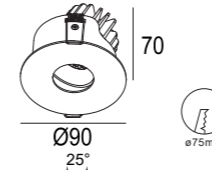
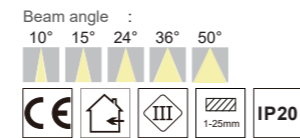

DL1428
 Power :1X7W/350mA/Max.19V
 CCT :2700/3000/4000K
 Flux :560lm
 CRI :≥92/85
 Cotout :ø75mm

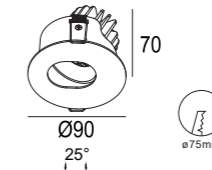
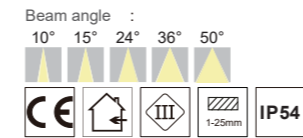

DL1427
 Power :1X7W/350mA/Max.19V
 CCT :2700/3000/4000K
 Flux :560lm
 CRI :≥92/85
 Cotout :ø75mm

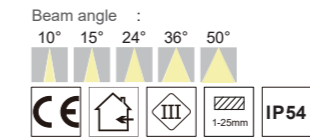

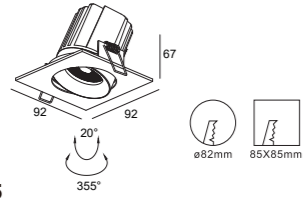

DL1005
 Power :1X10W/500mA/Max.19V
 CCT :2700/3000/4000K
 Flux :900lm
 CRI :≥92
 Cutout :ø82mm/85X85mm

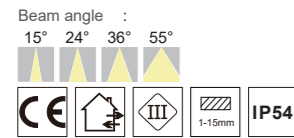

.DL1086
 Power :1X13W/350mA/Max.37V
 CCT :2700/3000/4000K
 Flux :1250lm
 CRI :≥92
 Cutout :ø82mm/85X85mm

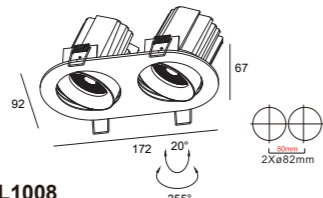
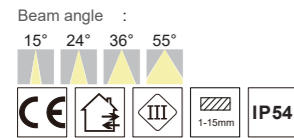

.DL1008
 Power :2X10W/500mA/2XMax.19V
 CCT :2700/3000/4000K
 Flux :2X900lm
 CRI :≥92
 Cutout :2xø82mm-80

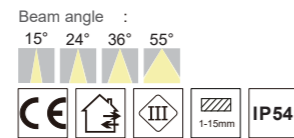

DL1089
 Power :2X13W/350mA/2XMax.37V
 CCT :2700/3000/4000K
 Flux :2X1250lm
 CRI :≥92
 Cutout :2xø82mm-80

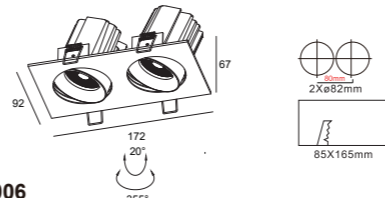
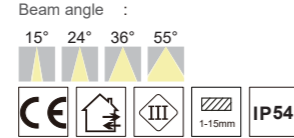

DL1006
 Power :2X10W/500mA/2XMax.19V
 CCT :2700/3000/4000K
 Flux :2X900lm
 CRI :≥92
 Cutout :2Xø82mm-80mm/85X165mm

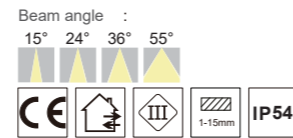

DL1087
 Power :2X13W/350mA/2XMax.37V
 CCT :2700/3000/4000K
 Flux :2X1250lm
 CRI :≥92
 Cutout :2Xø82mm-80mm/85X165mm

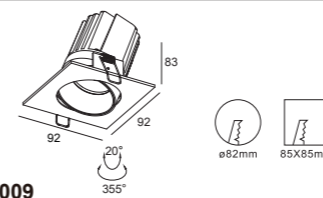
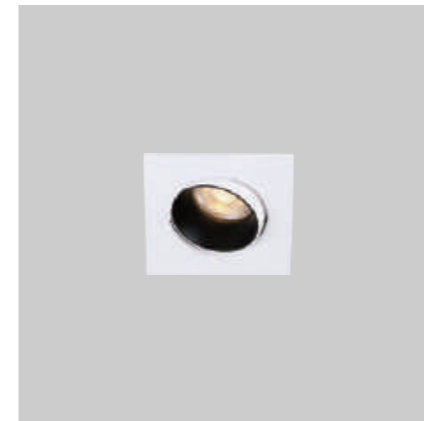
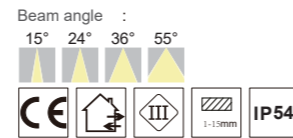

DL1009
 Power :1X10W/500mA/Max.19V
 CCT :2700/3000/4000K
 Flux :900lm
 CRI :≥92
 Cutout :ø82mm/85X85mm

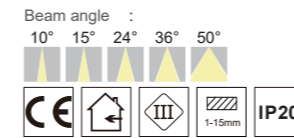

.DL1090
 Power :1X13W/350mA/Max.37V
 CCT :2700/3000/4000K
 Flux :1180lm
 CRI :≥92
 Cutout :ø82mm/85X85mm

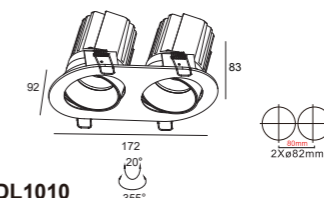
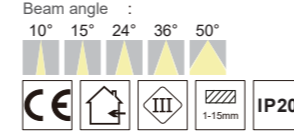

DL1010
 Power :2X10W/500mA/2XMax.19V
 CCT :2700/3000/4000K
 Flux :2X900lm
 CRI :≥92
 Cutout :2xø82-80mm

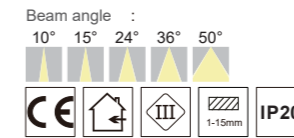

DL1093
 Power :2X13W/350mA/2XMax.37V
 CCT :2700/3000/4000K
 Flux :2X1180lm
 CRI :≥92
 Cutout :2Xø82-80mm

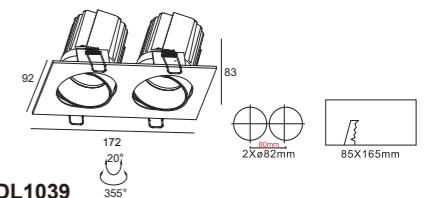
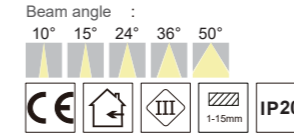

DL1039
 Power :2X10W/500mA/2XMax.19V
 CCT :2700/3000/4000K
 Flux :2X900lm
 CRI :≥92
 Cutout :2Xø82-80mm/85X165mm

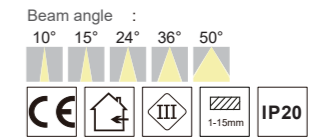

.DL1091
 Power :2X13W/350mA/2XMax.37V
 CCT :2700/3000/4000K
 Flux :2X1180lm
 CRI :≥92
 Cutout :2xø82-80mm/85X165mm

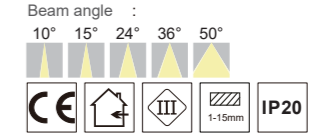

MAXI

COLOR: TW TB AB BC CP RG AG GL

LED CEILING RECESSED

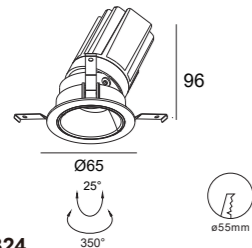
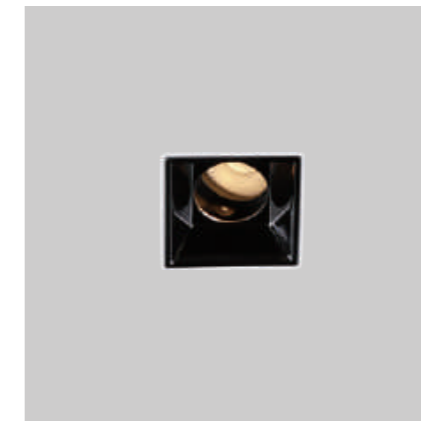
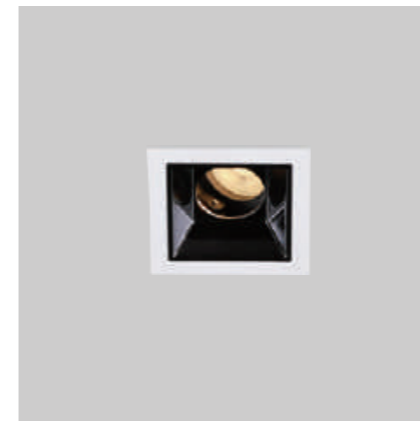
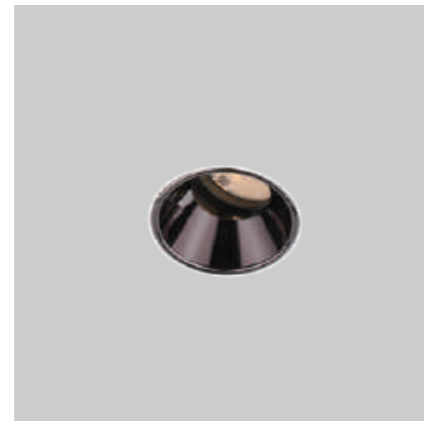
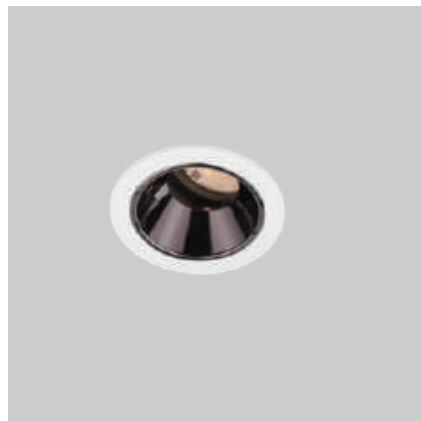

DL1324
 Power :1X7W/350mA/Max.19V
 1X10W/500mA/Max.19V
 CCT :2700/3000/4000K
 Flux :630lm/820lm
 CRI :≥92
 Cutout :ø55mm

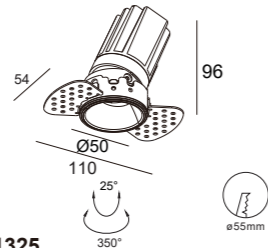
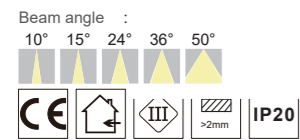

DL1325
 Power :1X7W/350mA/Max.19V
 1X10W/500mA/Max.19V
 CCT :2700/3000/4000K
 Flux :630lm/820lm
 CRI :≥92
 Cutout :ø55mm

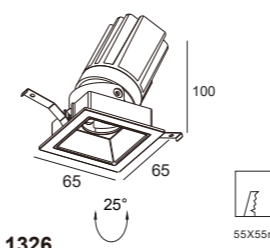
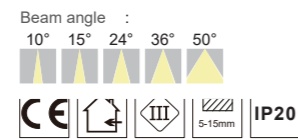

DL1326
 Power :1X7W/350mA/Max.19V
 1X10W/500mA/Max.19V
 CCT :2700/3000/4000K
 Flux :630lm/820lm
 CRI :≥92
 Cutout :55X55mm

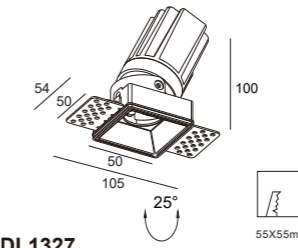
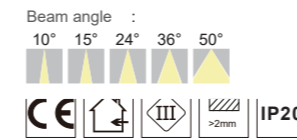

DL1327
 Power :1X7W/350mA/Max.19V
 1X10W/500mA/Max.19V
 CCT :2700/3000/4000K
 Flux :630lm/820lm
 CRI :≥92
 Cutout :55X55mm

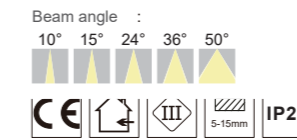

MAXI

COLOR: TW TB AB BC CP RG AG GL

LED CEILING RECESSED

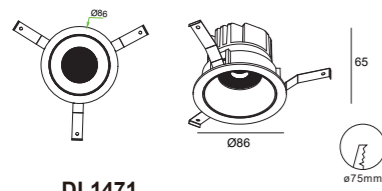
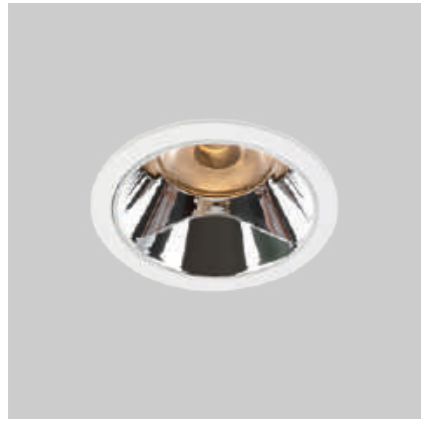

DL1471

Power :1X7W/350mA/Max.19V
 CCT :2700/3000/4000K
 Flux :630lm
 CRI :≥92
 Cutout :ø75mm

Beam angle :
 15° 24° 36° 55°

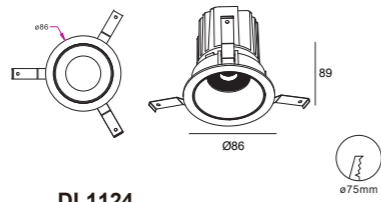

DL1124

Power :1X10W/500mA/Max.19V
 CCT :2700/3000/4000K
 Flux :900lm
 CRI :≥92
 Cutout :ø75mm

Beam angle :
 15° 24° 36° 55°

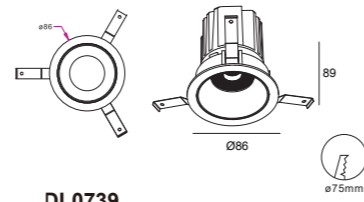

DL0739

Power :1X13W/350mA/Max.37V
 CCT :2700/3000/4000K
 Flux :1180lm
 CRI :≥92
 Cutout :ø75mm

Beam angle :
 15° 24° 36° 55°

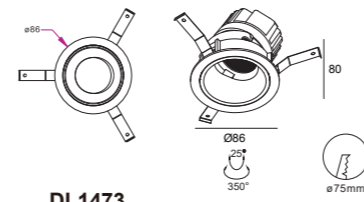
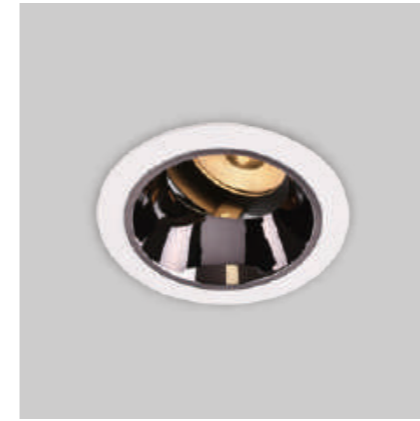

DL1473

Power :1X7W/350mA/Max.19V
 CCT :2700/3000/4000K
 Flux :630lm
 CRI :≥92
 Cutout :ø75mm

Beam angle :
 15° 24° 36° 55°

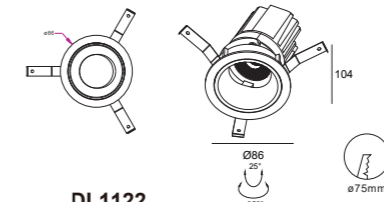

DL1122

Power :1X10W/500mA/Max.19V
 CCT :2700/3000/4000K
 Flux :900lm
 CRI :≥92
 Cutout :ø75mm

Beam angle :
 15° 24° 36° 55°

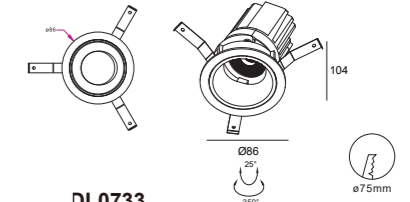

DL0733

Power :1X13W/350mA/Max.37V
 CCT :2700/3000/4000K
 Flux :1180lm
 CRI :≥92
 Cutout :ø75mm

Beam angle :
 15° 24° 36° 55°

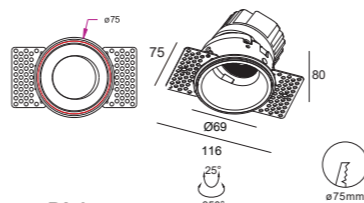

DL1474

Power :1X7W/350mA/Max.19V
 CCT :2700/3000/4000K
 Flux :630lm
 CRI :≥92
 Cutout :ø75mm

Beam angle :
 15° 24° 36° 55°

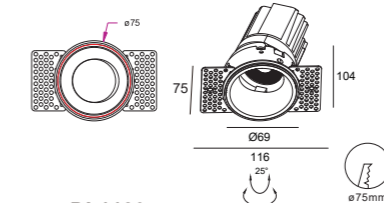

DL1123

Power :1X10W/500mA/Max.19V
 CCT :2700/3000/4000K
 Flux :900lm
 CRI :≥92
 Cutout :ø75mm

Beam angle :
 15° 24° 36° 55°

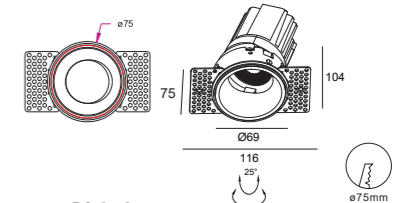

DL0734

Power :1X13W/350mA/Max.37V
 CCT :2700/3000/4000K
 Flux :1180lm
 CRI :≥92
 Cutout :ø75mm

Beam angle :
 15° 24° 36° 55°



MAXI

COLOR: TW TB AB BC CP RG AG GL

LED CEILING RECESSED

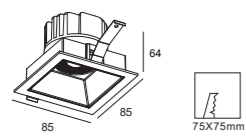
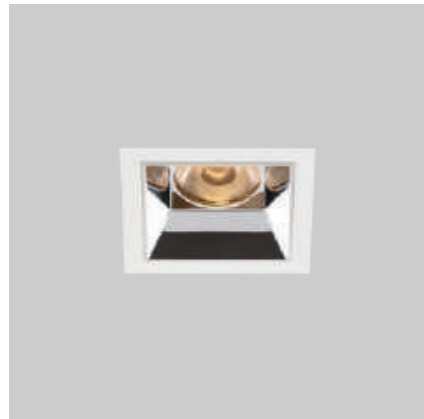

DL1475

Power :1X7W/350mA/Max.19V
 CCT :2700/3000/4000K
 Flux :630lm
 CRI :≥92
 Cutout :75X75mm

Beam angle :
 15° 24° 36° 55°

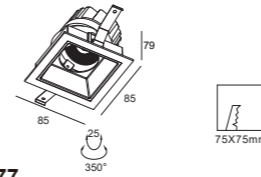
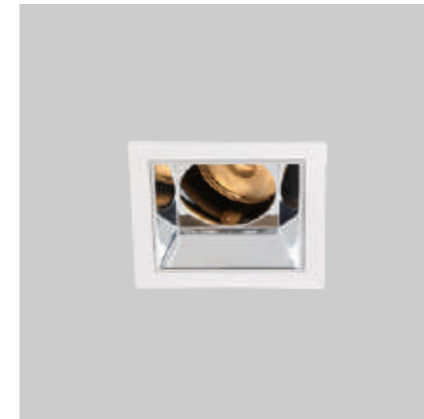

DL1477

Power :1X7W/350mA/Max.19V
 CCT :2700/3000/4000K
 Flux :630lm
 CRI :≥92
 Cutout :75X75mm

Beam angle :
 15° 24° 36° 55°

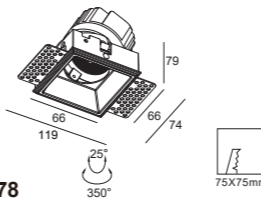
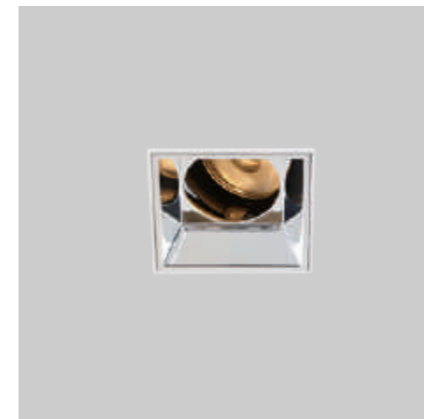

DL1478

Power :1X7W/350mA/Max.19V
 CCT :2700/3000/4000K
 Flux :630lm
 CRI :≥92
 Cutout :75X75mm

Beam angle :
 15° 24° 36° 55°

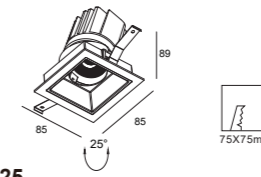

DL1125

Power :1X10W/500mA/Max.19V
 CCT :2700/3000/4000K
 Flux :900lm
 CRI :≥92
 Cutout :75X75mm

Beam angle :
 15° 24° 36° 55°

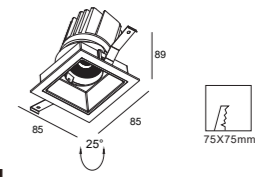

DL0064

Power :1X13W/350mA/Max.37V
 CCT :2700/3000/4000K
 Flux :1180lm
 CRI :≥92
 Cutout :75X75mm

Beam angle :
 15° 24° 36° 55°

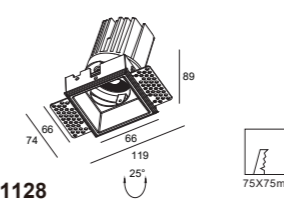

DL1128

Power :1X10W/500mA/Max.19V
 CCT :2700/3000/4000K
 Flux :900lm
 CRI :≥92
 Cutout :75X75mm

Beam angle :
 15° 24° 36° 55°

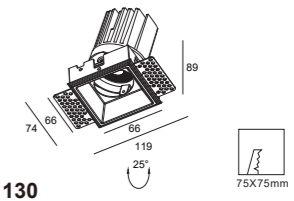

DL1130

Power :1X13W/350mA/Max.37V
 CCT :2700/3000/4000K
 Flux :1180lm
 CRI :≥92
 Cutout :75X75mm

Beam angle :
 15° 24° 36° 55°



MAXI

COLOR: TW TB AB BC CP RG AG GL

LED CEILING RECESSED

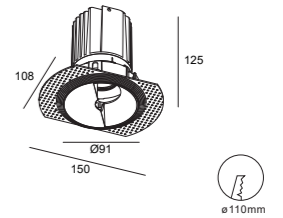
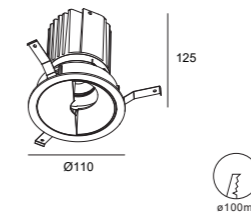
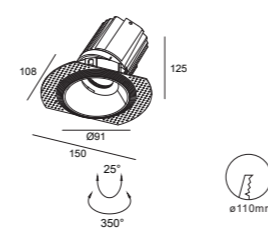
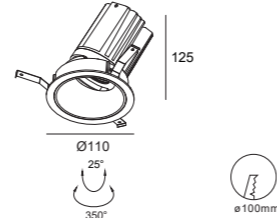
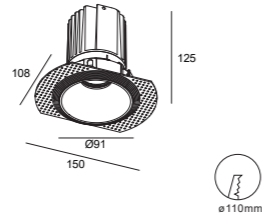
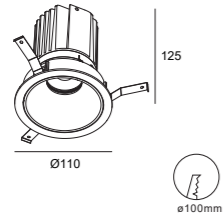
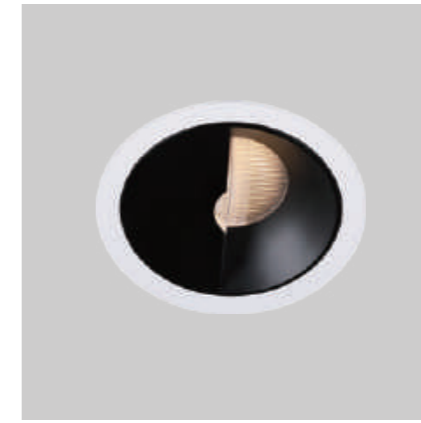
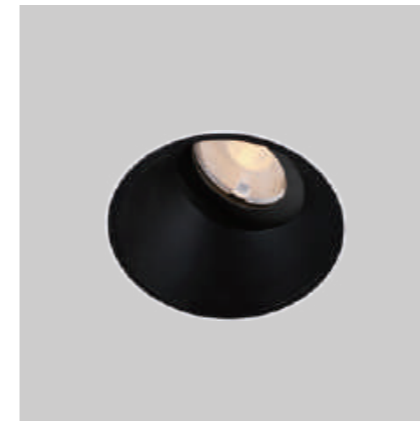

DL1374:1X18W/500mA/Max.37V
DL1361:1X26W/700mA/Max.37V

CCT :2700/3000/4000K
 Flux :1800lm/2600lm
 CRI :≥92
 Cutout :ø100mm

Beam angle :
 10° 15° 24° 36° 50°



DL1375:1X18W/500mA/Max.37V
DL1362:1X26W/700mA/Max.37V

CCT :2700/3000/4000K
 Flux :1800lm/2600lm
 CRI :≥92
 Cutout :ø110mm

Beam angle :
 10° 15° 24° 36° 50°



DL1328:1X18W/500mA/Max.37V
DL1154:1X26W/700mA/Max.37V

CCT :2700/3000/4000K
 Flux :1800lm/2600lm
 CRI :≥92
 Cutout :ø100mm

Beam angle :
 10° 15° 24° 36° 50°



DL1329:1X18W/500mA/Max.37V
DL1155:1X26W/700mA/Max.37V

CCT :2700/3000/4000K
 Flux :1800lm/2600lm
 CRI :≥92
 Cutout :ø100mm

Beam angle :
 10° 15° 24° 36° 50°



DL1491:1X18W/500mA/Max.37V
DL1365:1X26W/700mA/Max.37V

CCT :2700/3000/4000K
 Flux :1800lm/2600lm
 CRI :≥92
 Cutout :ø100mm

Beam angle :N/A



DL1492:1X18W/500mA/Max.37V
DL1366:1X26W/700mA/Max.37V

CCT :2700/3000/4000K
 Flux :1800lm/2600lm
 CRI :≥92
 Cutout :ø110mm

Beam angle :N/A



MAXI

COLOR: TW TB AB BC CP RG AG GL

LED CEILING RECESSED

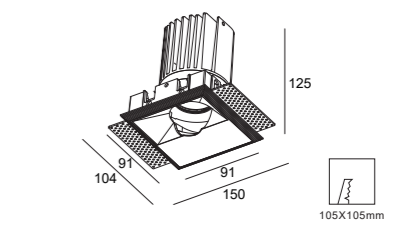
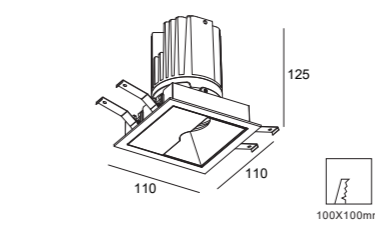
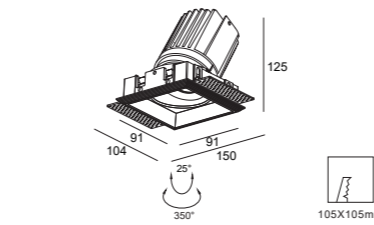
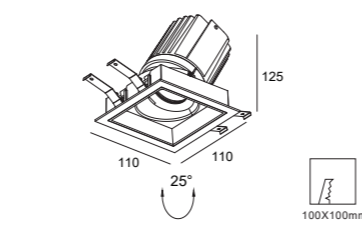
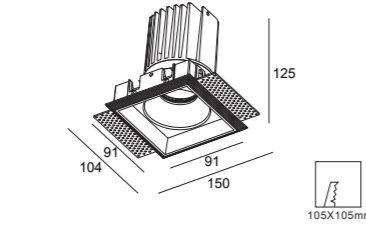
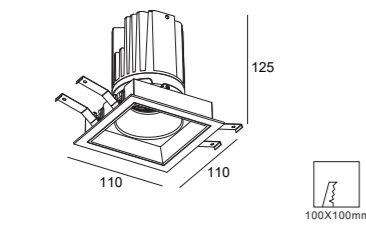
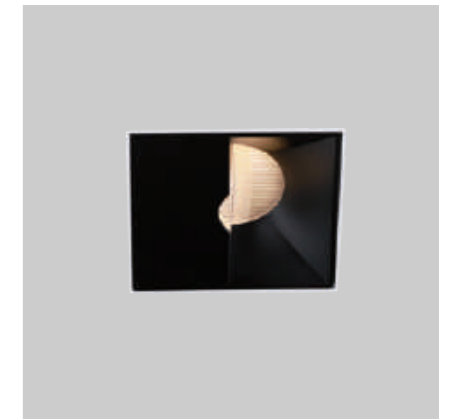
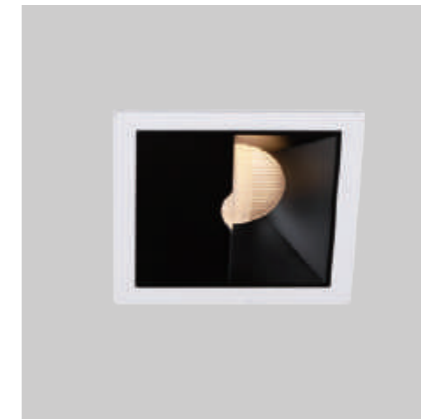

DL1376:1X18W/500mA/Max.37V
DL1363:1X26W/700mA/Max.37V

CCT :2700/3000/4000K
 Flux :1800lm/2600lm
 CRI :≥92
 Cutout :100X100mm

Beam angle :
 10° 15° 24° 36° 50°



DL1377:1X18W/500mA/Max.37V
DL1364:1X26W/700mA/Max.37V

CCT :2700/3000/4000K
 Flux :1800lm/2600lm
 CRI :≥92
 Cutout :105X105mm

Beam angle :
 10° 15° 24° 36° 50°



DL1330:1X18W/500mA/Max.37V
DL1156:1X26W/700mA/Max.37V

CCT :2700/3000/4000K
 Flux :1800lm/2600lm
 CRI :≥92
 Cutout :100X100mm

Beam angle :
 10° 15° 24° 36° 50°



DL1331:1X18W/500mA/Max.37V
DL1157:1X26W/700mA/Max.37V

CCT :2700/3000/4000K
 Flux :1800lm/2600lm
 CRI :≥92
 Cutout :105X105mm

Beam angle :
 10° 15° 24° 36° 50°



DL1493:1X18W/500mA/Max.37V
DL1367:1X26W/700mA/Max.37V

CCT :2700/3000/4000K
 Flux :1800lm/2600lm
 CRI :≥92
 Cutout :100X100mm

Beam angle :
 10° 15° 24° 36° 50°



DL1494:1X18W/500mA/Max.37V
DL1368:1X26W/700mA/Max.37V

CCT :2700/3000/4000K
 Flux :1800lm/2600lm
 CRI :≥92
 Cutout :105X105mm

Beam angle :
 10° 15° 24° 36° 50°



MAXI

COLOR: TW TB AB BC CP RG AG GL

LED CEILING RECESSED

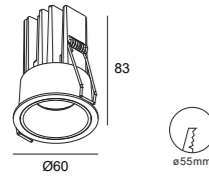
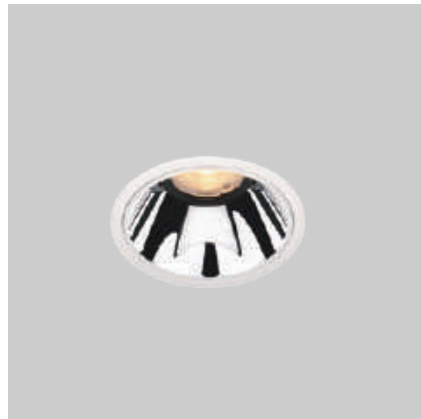

DL1264

Power :1X7W/350mA/Max.19V
1X10W/500mA/Max.19V
CCT :2700/3000/4000K
Flux :2700lm/3000lm/4000lm
CRI :≥92
Cutout :ø55mm

Beam angle : 10° 15° 24° 36° 50°

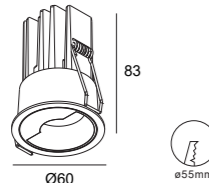
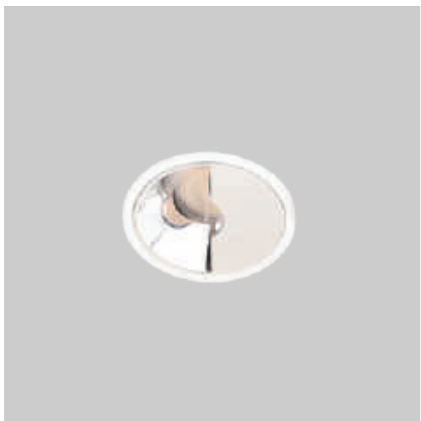

DL1265

Power :1X7W/350mA/Max.19V
1X10W/500mA/Max.19V
CCT :2700/3000/4000K
Flux :630lm/960lm
CRI :≥92
Cutout :ø55mm

Beam angle :N/A

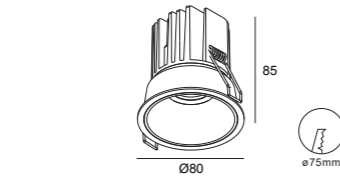

DL1260

Power :1X13W/350mA/Max.37V
CCT :2700/3000/4000K
Flux :1180lm
CRI :≥92
Cutout :ø75mm

Beam angle : 10° 15° 24° 36° 50°

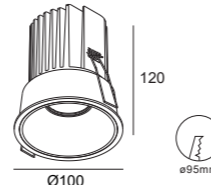

DL1268

Power :1X26W/700mA/Max.37V
CCT :2700/3000/4000K
Flux :2600lm
CRI :≥92
Cutout :ø95mm

Beam angle : 10° 15° 24° 36° 50°

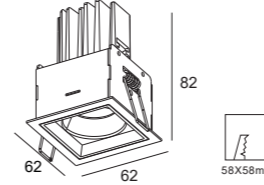

DL1266

Power :1X7W/350mA/Max.19V
1X10W/500mA/Max.19V
CCT :2700/3000/4000K
Flux :2700lm/3000lm/4000lm
CRI :≥92
Cutout :58X58mm

Beam angle : 10° 15° 24° 36° 50°

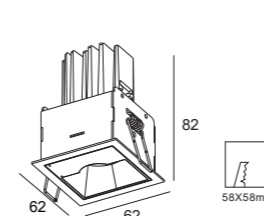
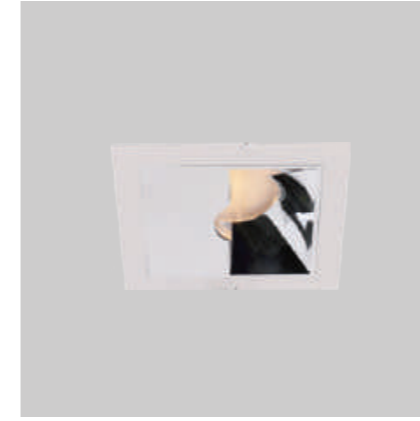

DL1267

Power :1X7W/350mA/Max.19V
1X10W/500mA/Max.19V
CCT :2700/3000/4000K
Flux :630lm/960lm
CRI :≥92/85
Cutout :58X58mm

Beam angle :N/A

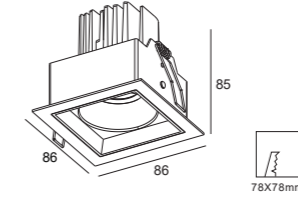

DL1262

Power :1X13W/350mA/Max.37V
CCT :2700/3000/4000K
Flux :1180lm
CRI :≥92
Cutout :78X78mm

Beam angle : 10° 15° 24° 36° 50°

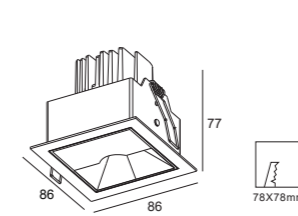

DL1263

Power :1X13W/350mA/Max.37V
CCT :2700/3000/4000K
Flux :1180lm
CRI :≥92
Cutout :78X78mm

Beam angle :N/A



BET

COLOR: TW TB

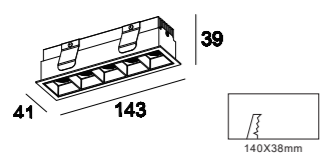
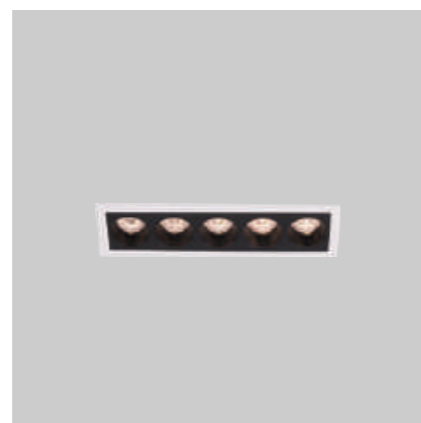

DL1179

Power :1X10W/350mA/Max.30V
CCT :2700/3000/4000K
Flux :960lm
CRI :≥92
Cutout :140X38mm

Beam angle

12° 24°

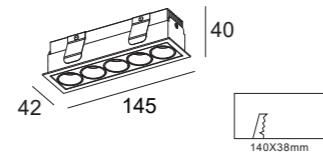

DL1479

Power :10W/350mA/Max.30V
CCT :2700/3000/4000K
Flux :960lm
CRI :≥92
Cutout :140X38mm

Beam angle

12° 24°



BET

COLOR: TW TB

LED CEILING RECESSED

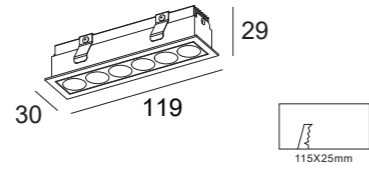
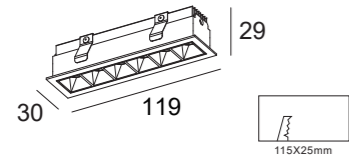
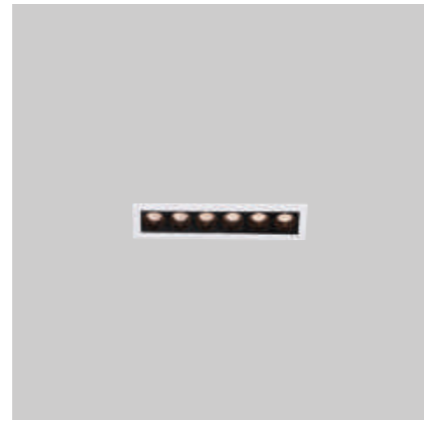
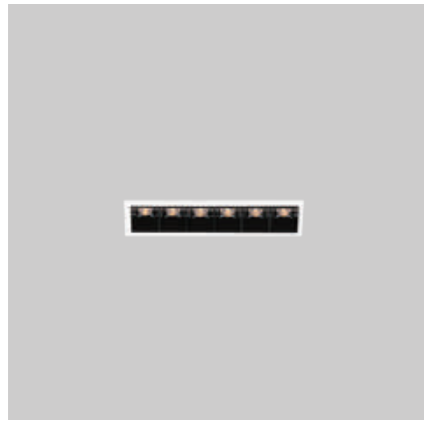

DL1274
 Power :6X1W/180mA/Max.36V
 CCT :2700/3000/4000K
 Flux :630lm
 CRI :≥92
 Cutout :115X25mm

DL1480
 Power :6X1W/180mA/Max.36V
 CCT :2700/3000/4000K
 Flux :630lm
 CRI :≥92
 Cutout :115X25mm

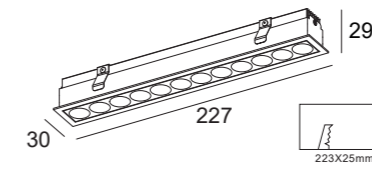
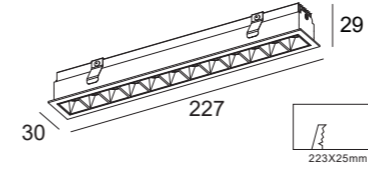
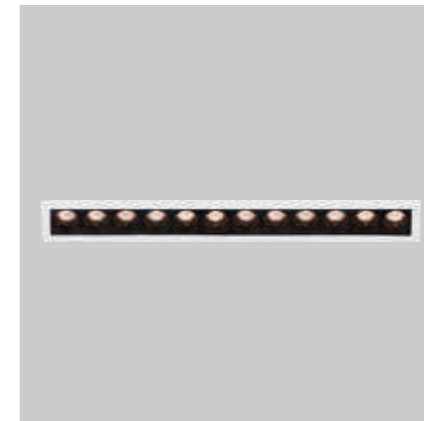
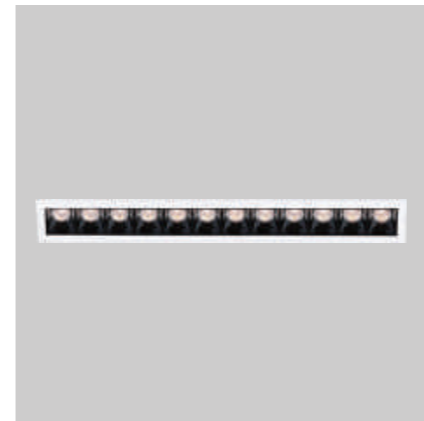
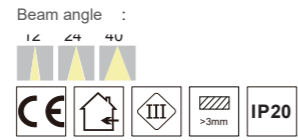
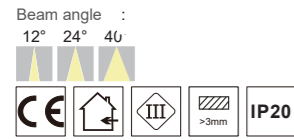

DL1481
 Power :1X13W/350mA/Max.36V
 CCT :2700/3000/4000K
 Flux :1300lm
 CRI :≥92
 Cutout :223X25mm

DL1482
 Power :1X13W/350mA/Max.36V
 CCT :2700/3000/4000K
 Flux :1300lm
 CRI :≥92
 Cutout :223X25mm

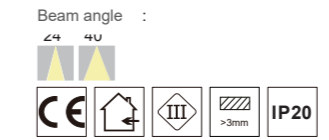
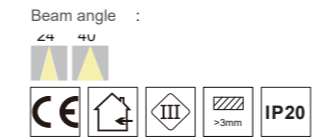

BET

COLOR: TW TB

LED CEILING RECESSED

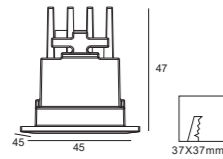
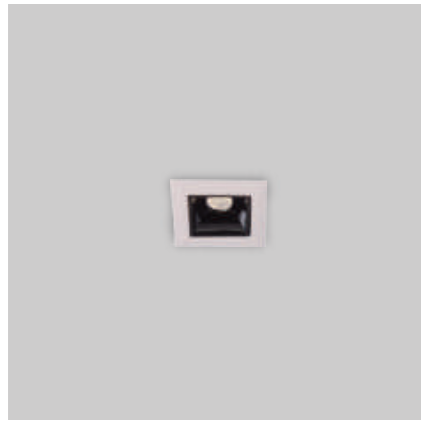

DL0403
 Power :1X2W/700mA/Max.3V
 CCT :2700/3000/4000K
 Flux :160lm
 CRI :≥92/85
 Cutout :37X37mm

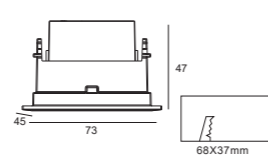
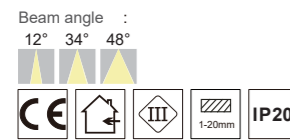

DL0404
 Power :2X2W/700mA/2xMax.3V
 CCT :2700/3000/4000K
 Flux :320lm
 CRI :≥92/85
 Cutout :68X37mm

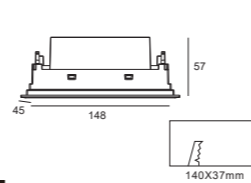
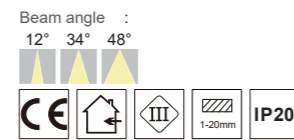

DL0405
 Power :5X2W/700mA/5xMax.3V
 CCT :2700/3000/4000K
 Flux :800lm
 CRI :≥92/85
 Cutout :140X37mm

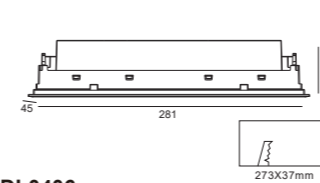
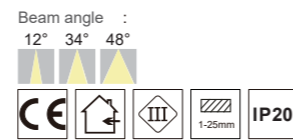

DL0406
 Power :10X2W/700mA/10xMax.3V
 CCT :2700/3000/4000K
 Flux :1600lm
 CRI :≥92/85
 Cutout :273X37mm

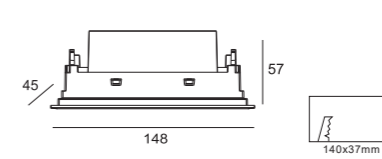
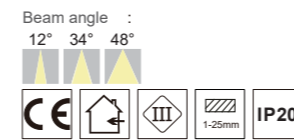

DL0575
 Power :5X2W/700mA/Max.3V
 CCT :2700/3000/4000K
 Flux :800lm
 CRI :≥92
 Cutout :140x37mm

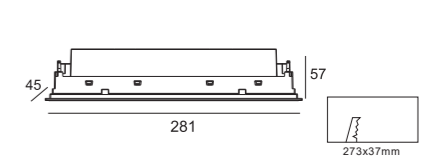

DL0576
 Power :10X2W/700mA/Max.3V
 CCT :2700/3000/4000K
 Flux :1600lm
 CRI :≥92
 Cutout :273x37mm

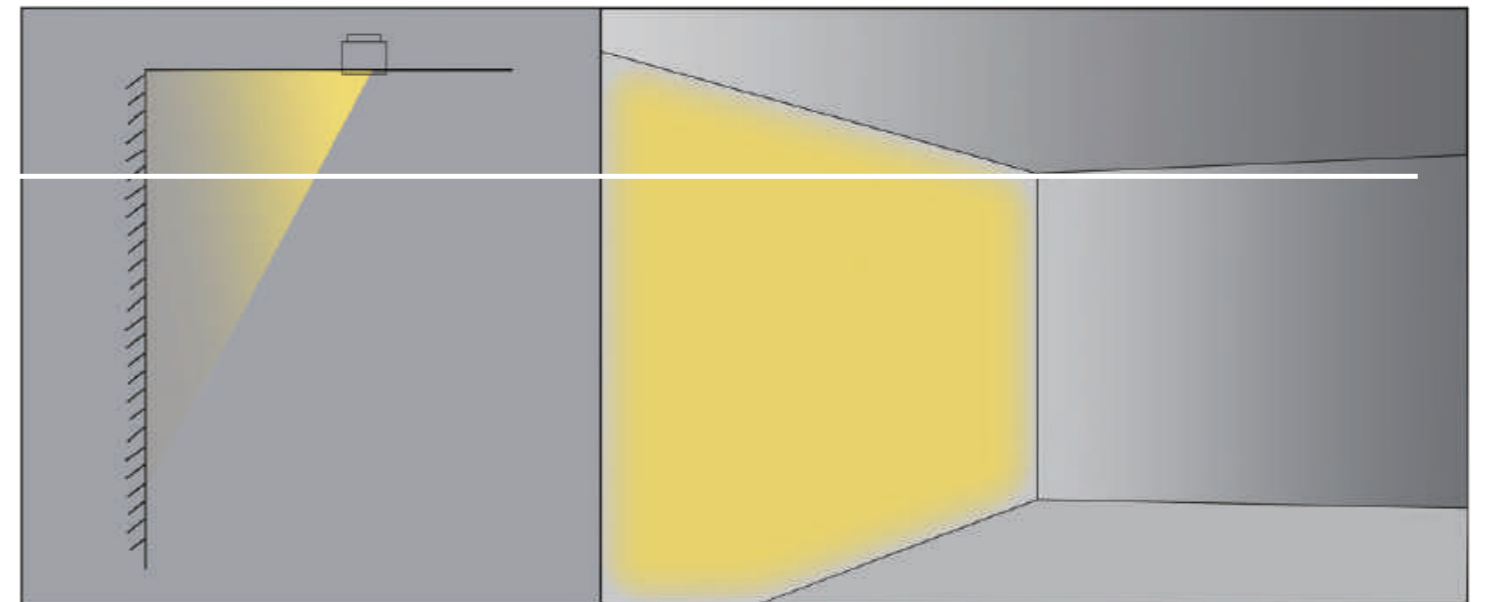

WALL WASHER

BET

COLOR: TW TB

LED CEILING RECESSED

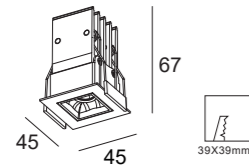
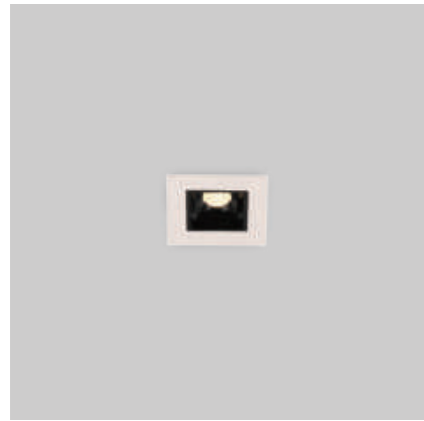

DL0058
 Power :7W/180mA/Max.37V
 CCT :2700/3000/4000K
 Flux :580lm
 CRI :≥92
 Cutout :39X39mm

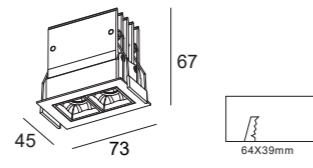
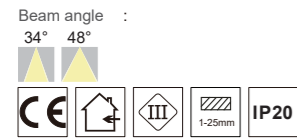

DL0059
 Power :13W/350mA/Max.37V
 CCT :2700/3000/4000K
 Flux :1200lm
 CRI :≥92
 Cutout :64X39mm

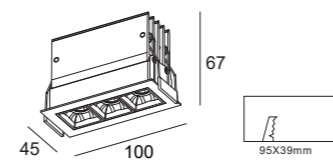
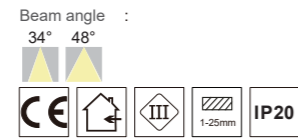

DL0060
 Power :18W/500mA/Max.37V
 CCT :2700/3000/4000K
 Flux :1800lm
 CRI :≥92
 Cutout :95X39mm

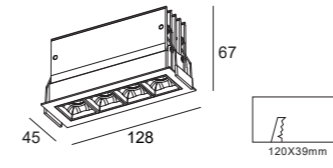
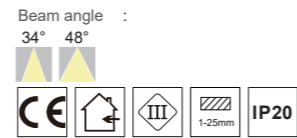

DL0061
 Power :22W/600mA/Max.37V
 CCT :2700/3000/4000K
 Flux :2200lm
 CRI :≥92
 Cutout :120X39mm

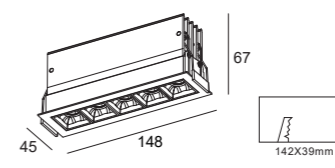
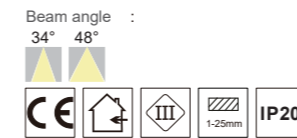

DL0062
 Power :26W/700mA/Max.37V
 CCT :2700/3000/4000K
 Flux :2600lm
 CRI :≥92
 Cutout :142X39mm

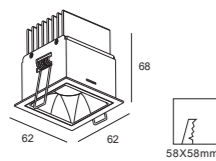
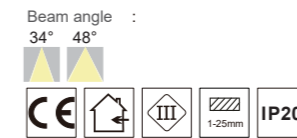

DL0509
 Power :7W/350mA/Max.19V
 CCT :2700/3000/4000K
 Flux :650lm
 CRI :≥92
 Cutout :58x58mm

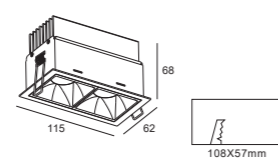
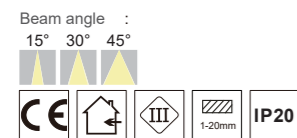

DL0650
 Power :13W/350mA/2xMax.19V
 CCT :2700/3000/4000K
 Flux :2x650lm
 CRI :≥92
 Cutout :108x57mm

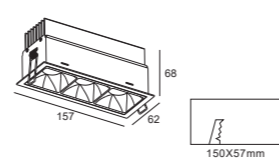
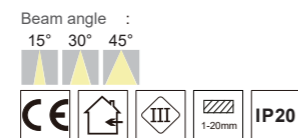

DL0651
 Power :19W/350mA/3xMax.19V
 CCT :2700/3000/4000K
 Flux :3X650lm
 CRI :≥92
 Cutout :150X57mm

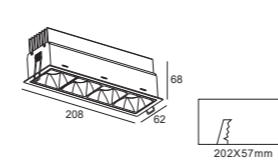
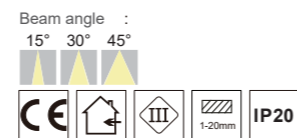

DL0753
 Power :22W/700mA/4xMax.10V
 CCT :2700/3000/4000K
 Flux :4X650lm
 CRI :≥92
 Cutout :202X57mm

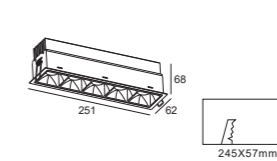
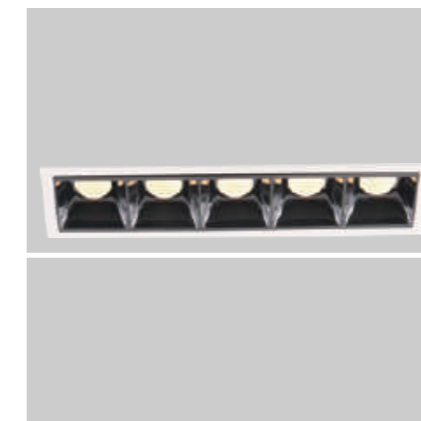
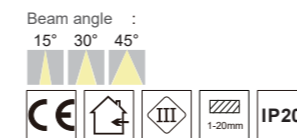

DL0754
 Power :26W/700mA/5xMax.10V
 CCT :2700/3000/4000K
 Flux :5X650m
 CRI :≥92
 Cutout :245X57mm

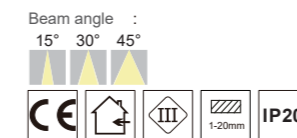

BET

COLOR: TW TB

LED CEILING RECESSED

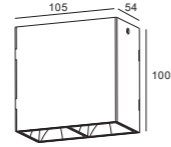
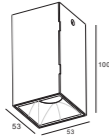

CH0152

Power :1X8W/AC230V-50Hz
 CCT :2700/3000/4000K
 Flux :650lm
 CRI :≥92

CH0120

Power :2X7W/AC230V-50Hz
 CCT :2700/3000/4000K
 Flux :2X650lm
 CRI :≥92

Beam angle :
 15° 30° 45°



Beam angle :
 15° 30° 45°

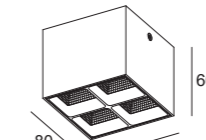
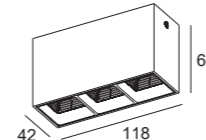

CH0157

Power :1X10W/AC230V-50Hz
 CCT :2700/3000/4000K
 Flux :960lm
 CRI :≥92

CH0158

Power :1X15W/AC230V-50Hz
 CCT :2700/3000/4000K
 Flux :1300lm
 CRI :≥92

Beam angle :
 15° 24° 38° 50° 55x55° 75x75° 35x75°



Beam angle :
 15° 24° 38° 50° 55x55° 75x75° 35x75°

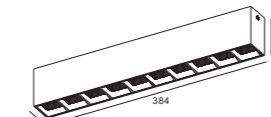
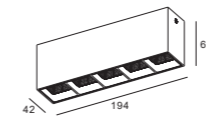
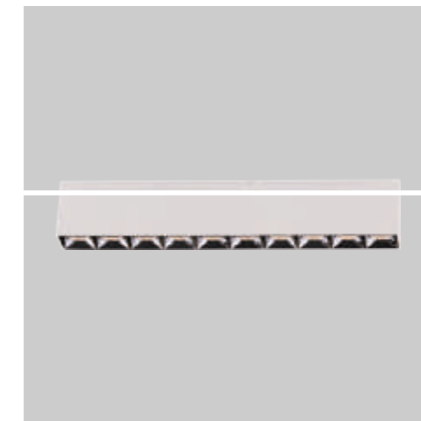

CH0159

Power :20W/AC230V-50Hz
 CCT :2700/3000/4000K
 Flux :1800lm
 CRI :≥92

CH0167

Power :30W/AC230V-50Hz
 CCT :2700/3000/4000K
 Flux :2700lm
 CRI :≥92

Beam angle :
 15° 24° 38° 50° 55x55° 75x75° 35x75°



Beam angle :
 15° 24° 38° 50° 55x55° 75x75° 35x75°



BET

COLOR: TW TB

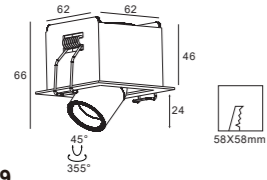
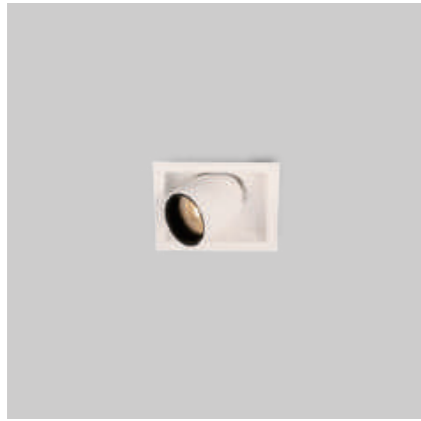

DL0759

Power :1X3W/350mA/Max.10V
 CCT :2700/3000/4000K
 Flux :280lm
 CRI :≥92
 Cutout :58X58mm

Beam angle :

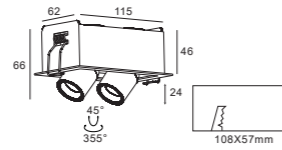

DL0760

Power :2X3W/350mA/2XMax.10V
 CCT :2700/3000/4000K
 Flux :2X280lm
 CRI :≥92
 Cutout :108X57mm

Beam angle :

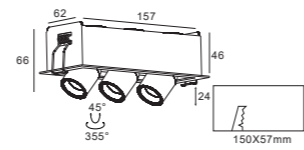
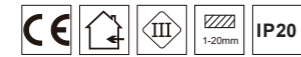

DL0761

Power :3X3W/350mA/3XMax.10V
 CCT :2700/3000/4000K
 Flux :3X280lm
 CRI :≥92
 Cutout :150X57mm

Beam angle :

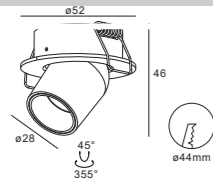
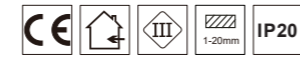

DL0667

Power :1X3W/350mA/Max.10V
 CCT :2700/3000/4000K
 Flux :280lm
 CRI :≥92
 Cutout :ø44mm

Beam angle :

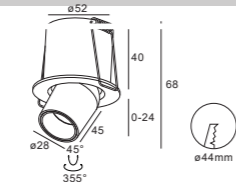
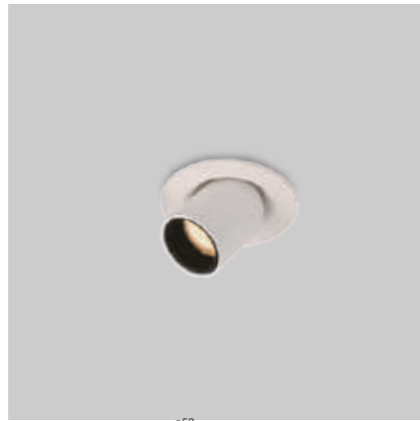

DL0728

Power :1X3W/350mA/Max.10V
 CCT :2700/3000/4000K
 Flux :280lm
 CRI :≥92
 Cutout :ø44mm

Beam angle :



BET

COLOR: TW TB

LED CEILING RECESSED

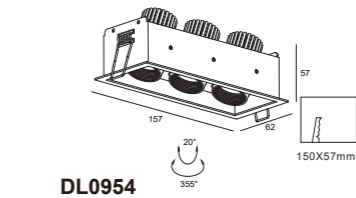
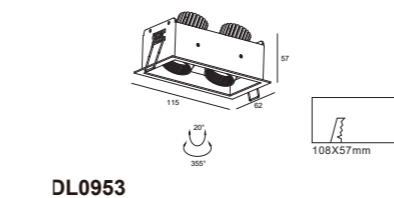
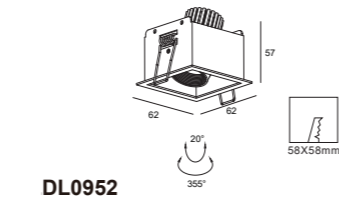
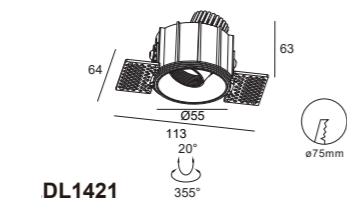
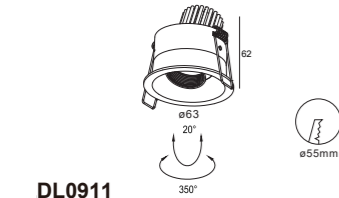
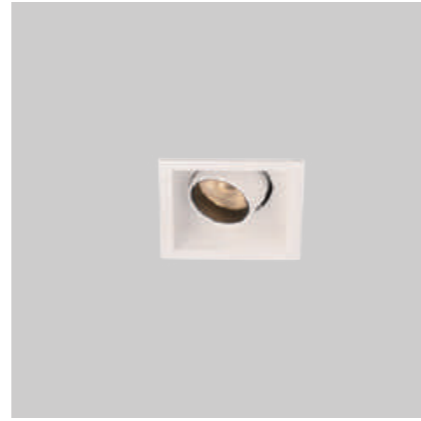

DL0911
 Power :1X5W/500mA/Max.10V
 CCT :2700/3000/4000K
 Flux :480lm
 CRI :≥92
 Cutout :ø55mm

DL1421
 Power :1X5W/500mA/Max.10V
 CCT :2700/3000/4000K
 Flux :480lm
 CRI :≥92
 Cutout :ø75mm

DL0952
 Power :1X5W/500mA/Max.10V
 CCT :2700/3000/4000K
 Flux :480lm
 CRI :≥92
 Cutout :58X58mm

DL0953
 Power :2X5W/500mA/2XMax.10V
 CCT :2700/3000/4000K
 Flux :2X480lm
 CRI :≥92
 Cutout :108X57mm

DL0954
 Power :3X5W/500mA/3XMax.10V
 CCT :2700/3000/4000K
 Flux :3x480lm
 CRI :≥92
 Cutout :150X57mm

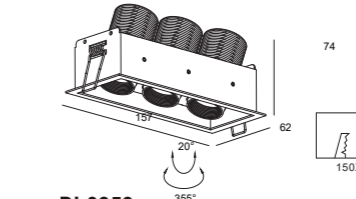
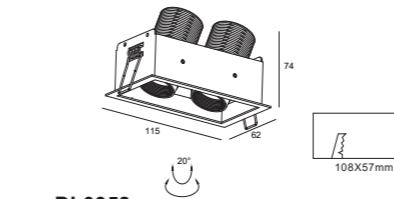
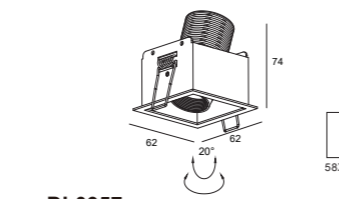
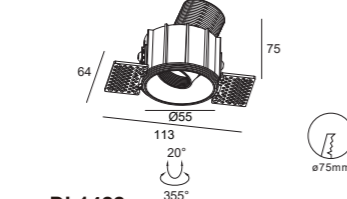
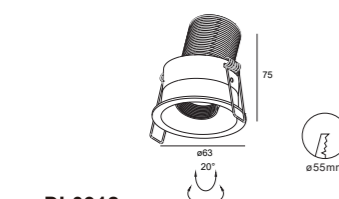
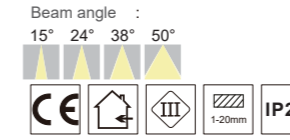
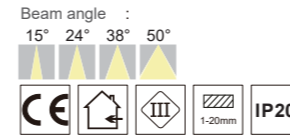
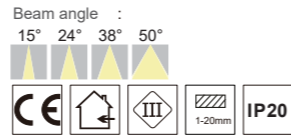
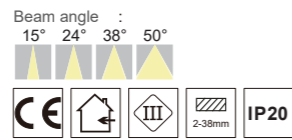
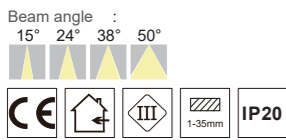

DL0912
 Power :1X7W/350mA/Max.19V
 CCT :2700/3000/4000K
 Flux :630lm
 CRI :≥92
 Cutout :ø55mm

DL1422
 Power :1X7W/350mA/Max.19V
 CCT :2700/3000/4000K
 Flux :630lm
 CRI :≥92
 Cutout :ø75mm

DL0957
 Power :1X7W/350mA/Max.19V
 CCT :2700/3000/4000K
 Flux :630lm
 CRI :≥92
 Cutout :58X58mm

DL0958
 Power :2X7W/350mA/2XMax.19V
 CCT :2700/3000/4000K
 Flux :2x630lm
 CRI :≥92
 Cutout :108X57mm

DL0959
 Power :3X7W/350mA/3XMax.19V
 CCT :2700/3000/4000K
 Flux :3X630lm
 CRI :≥92
 Cutout :150X57mm

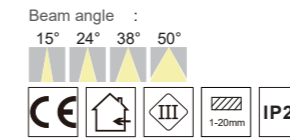
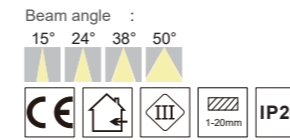
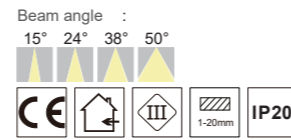
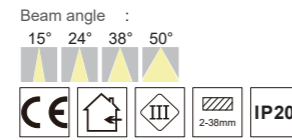
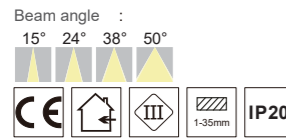

DOT

COLOR: TW TB

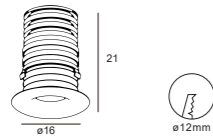

DL0178

Power :1X1W/350mA/Max.3V
CCT :2700/3000/4000K
Flux :80lm
CRI :≥80
Cutout :ø12mm

Beam angle :

50°

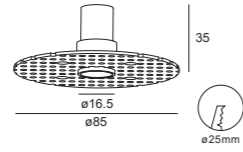

DL0251

Power :1X1W/350mA/Max.3V
CCT :2700/3000/4000K
Flux :80lm
CRI :≥85
Cutout :ø25mm

Beam angle :

50°

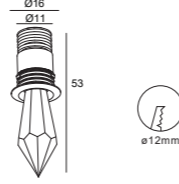

DL1449

Power :1X1W/350mA/Max.3V
CCT :2700/3000/4000K
Flux :80lm
CRI :≥80
Cutout :ø12mm

Beam angle :N/A



DOT

COLOR: TW TB

LED CEILING RECESSED

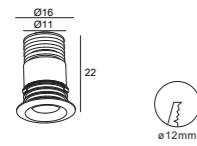
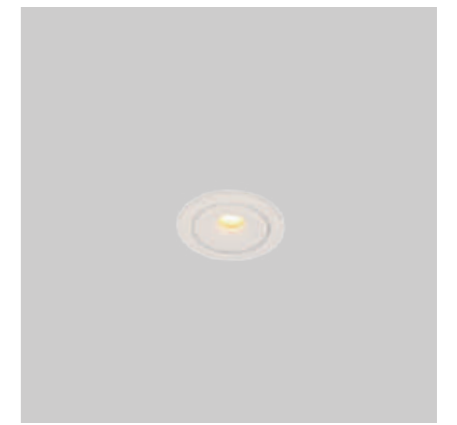
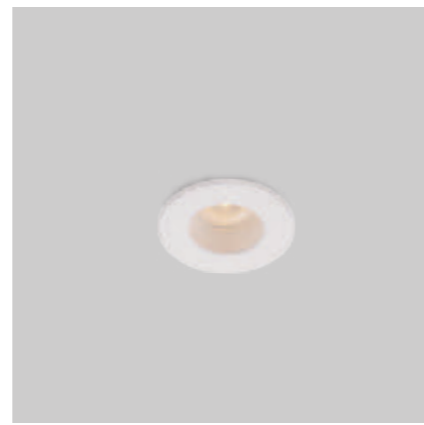
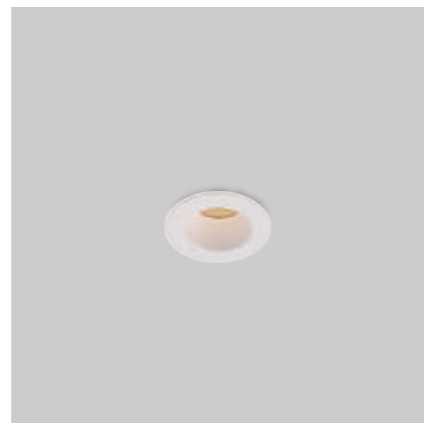
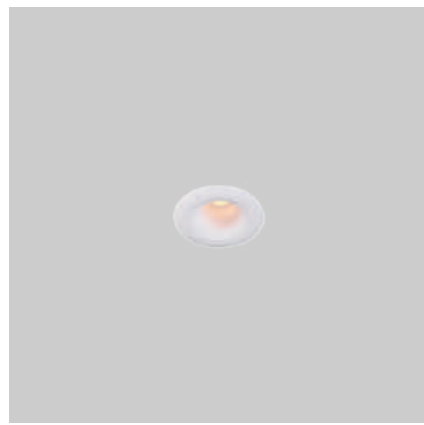

DL1419
 Power :1X1W/350mA/Max.3V
 CCT :2700/3000/4000K
 Flux :80lm
 CRI :≥80
 Cutout :Ø12mm

Beam angle :N/A

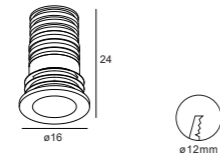

DL0308
 Power :1X1W/350mA/Max.3V
 CCT :2700/3000/4000K
 Flux :80lm
 CRI :≥85
 Cutout :Ø12mm

Beam angle :
 50°

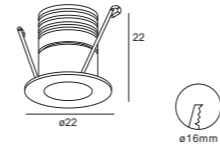

DL0629
 Power :1X1W/350mA 1X2W/700mA/Max.3V
 CCT :2700/3000/4000K
 Flux :70lm/150lm
 CRI :≥85
 Cutout :Ø16mm

Beam angle :
 15° 24° 36° 60°

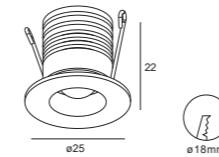

DL0802
 Power :1X2W/700mA/Max.3V
 CCT :2700/3000/4000K
 Flux :180lm
 CRI :≥92
 Cutout :Ø18mm

Beam angle :
 16°

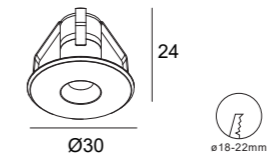

DL1149
 Power :1X1W/350mA/Max.3V
 CCT :2700/3000/4000K
 Flux :90lm
 CRI :≥80
 Cutout :Ø18-22mm

Beam angle :
 50°

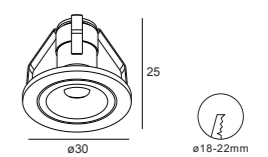

DL0017
 Power :1X1W/350mA/Max.3V
 CCT :2700/3000/4000K
 Flux :80lm
 CRI :≥80
 Cutout :Ø18-22mm

Beam angle :
 50°



DL0555

Power :1X1W/DC24V
 CCT :2700/3000/4000K
 Flux :60lm
 CRI :≥85
 Cutout :Ø16mm

Beam angle :
 15° 24° 36° 60°



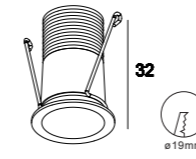
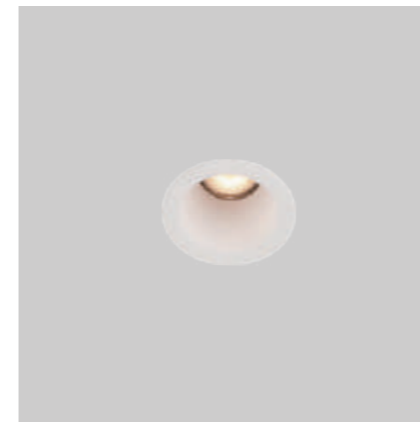

DL1206 Ø22

Power :1X2W/700mA/Max.3V
 CCT :2700/3000/4000K
 Flux :160lm
 CRI :≥92
 Cutout :ø19mm

Beam angle :
 15° 24° 36° 60°

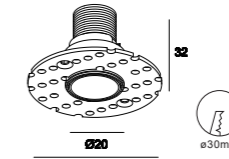
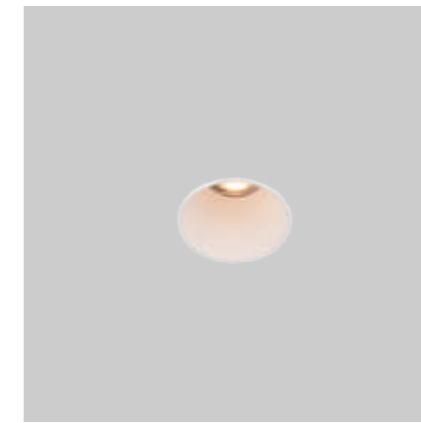

DL1207 Ø20

Power :1X2W/700mA/Max.3V
 CCT :2700/3000/4000K
 Flux :160lm
 CRI :≥92
 Cutout :ø30mm

Beam angle :
 15° 24° 36° 60°

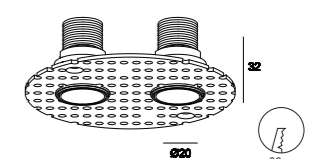

DL1208 Ø20

Power :2X2W/700mA/2XMax.3V
 CCT :2700/3000/4000K
 Flux :320lm
 CRI :≥92/85
 Cutout :ø63mm

Beam angle :
 15° 24° 36° 60°

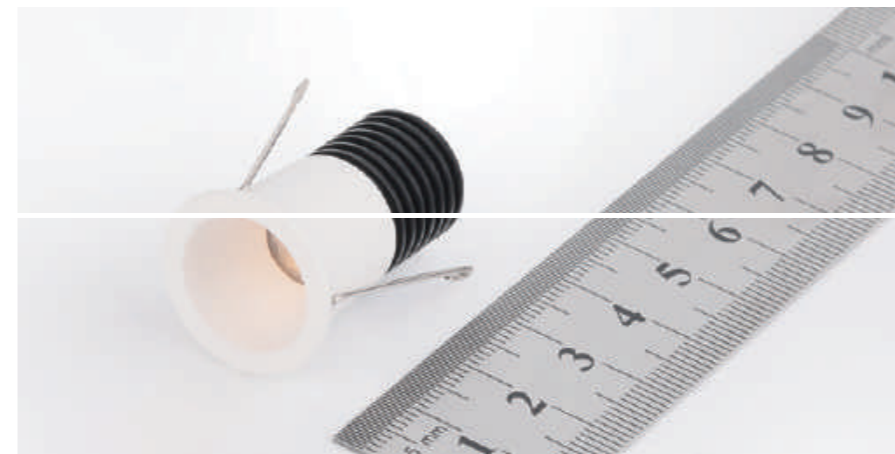

Colour:



TB AB BC TW CP AG GL RG

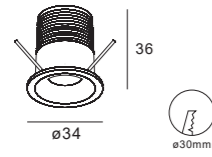
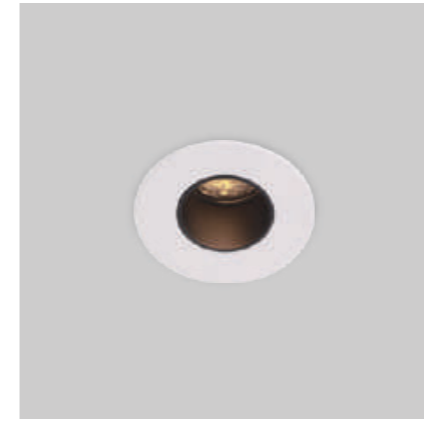
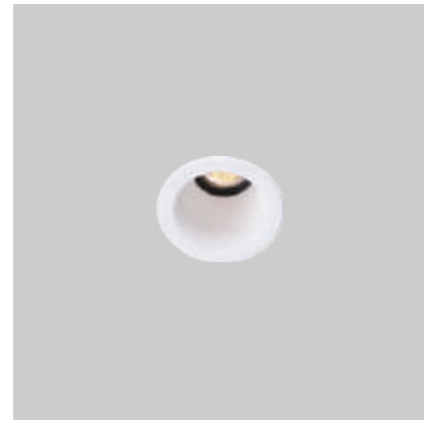

DL1279

Power :1X2W/700mA/Max.3V
 CCT :2700/3000/4000K
 Flux :150lm
 CRI :≥85
 Cutout :ø30mm

Beam angle :
 15° 24° 36° 60°

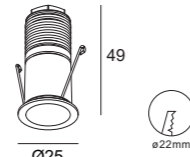

DL1409

Power :1X2W/700mA/Max.3V
 CCT :2700/3000/4000K
 Flux :70lm/150lm
 CRI :≥85
 Cutout :ø22mm

Beam angle :
 15° 24° 36° 60°

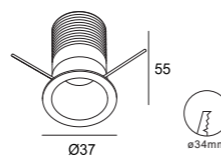

DL1410

Power :1X2W/700mA/Max.3V
 CCT :2700/3000/4000K
 Flux :180lm
 CRI :≥92
 Cutout :ø34mm

Beam angle :
 15° 24° 36° 60°

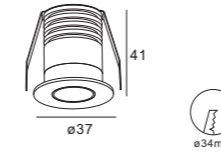

DL1335

Power :1X1W/350mA 1X2W/700mA/Max.3V
 CCT :1X1W/DC24V
 CCT :2700/3000/4000K
 Flux :72lm/140lm
 CRI :≥92/85
 Cutout :ø34mm

Beam angle :
 15° 24° 36° 60°

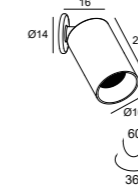

DL1248

Power :1W/350mA/DC24V 1X1W/350mA/Max.3V
 CCT :2700/3000/4000K
 Flux :160lm
 CRI :≥92
 Cutout :N/A

Beam angle :
 15° 24° 36° 60°



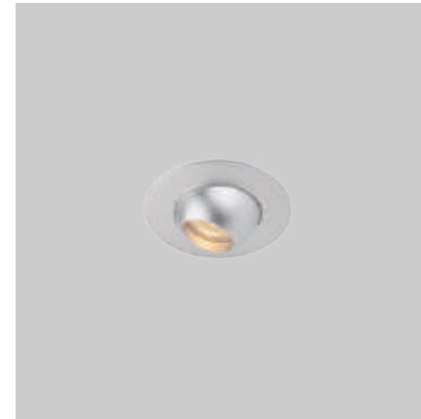

DL1246

Power :1X1W/350mA/Max.3V /1X1W/DC24V
 CCT :2700/3000/4000K
 Flux :160lm
 CRI :≥92
 Cutout :ø25mm

DL1247

Power :1X1W/350mA/Max.3V / 1X1W/DC24V
 CCT :2700/3000/4000K
 Flux :160lm
 CRI :≥92
 Cutout :ø25mm

Beam angle :



Beam angle :

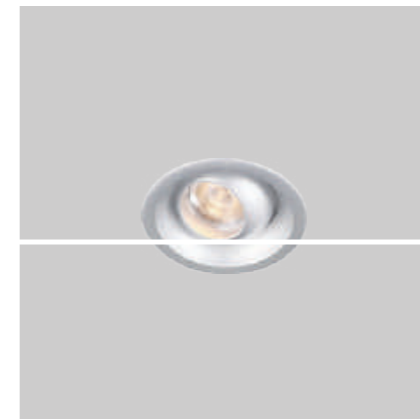
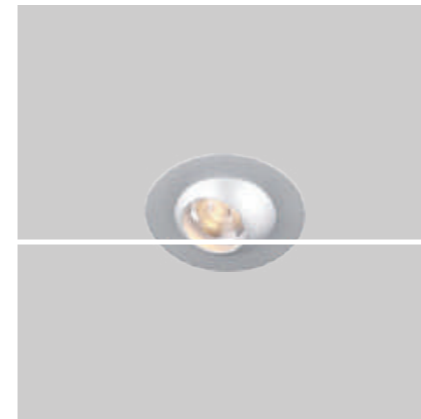

DL1445

Power :1X3W/350mA/Max.10V / 1X3W/DC24V
 CCT :2700/3000/4000K
 Flux :280lm
 CRI :≥92
 Cutout :ø40mm

DL1444

Power :1X3W/350mA/Max.10V / 1X3W/DC24V
 CCT :2700/3000/4000K
 Flux :280lm
 CRI :≥92
 Cutout :ø40mm

Beam angle :



Beam angle :



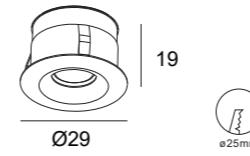

DL1453
 Power :1W/350mA/2W/700mA/Max.3V
 CCT :2700/3000/4000K
 Flux :90lm/160lm
 CRI :≥92
 Cuout :ø25mm

Beam angle :
 15° 24° 36° 60°

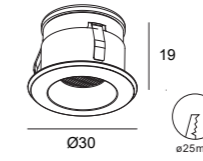

DL0941
 Power :1X1W/DC24V
 1X2W/700mA/Max.3V
 CCT :2700/3000/4000K
 Flux :90lm/160lm
 CRI :≥92
 Cutout :ø25mm

Beam angle :
 20° 40° 120°

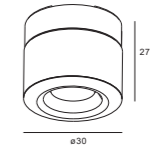

DL1143
 Power :1X1W/DC24V
 1X2W/700mA/Max.3V
 CCT :2700/3000/4000K
 Flux :90lm
 CRI :≥92
 Cutout :N/A

Beam angle :
 20° 40° 120°

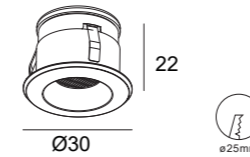
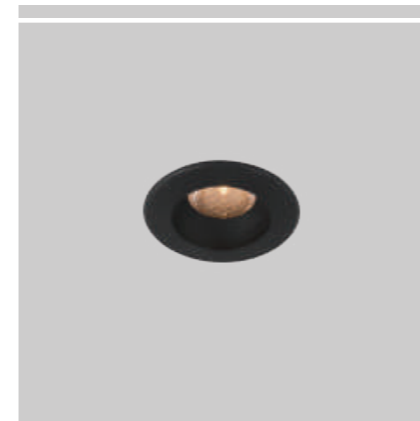

DL1148
 Power :1×1W/DC24V / 1×1W/350mA/Max.3V
 1×2W/700mA/Max.3V
 CCT :2700/3000/4000K
 Flux :90lm/160lm
 CRI :≥92
 Cuout :ø25mm

Beam angle :
 20° 40° 120°

DOT

COLOR: TW TB BV

LED CEILING RECESSED

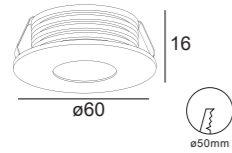
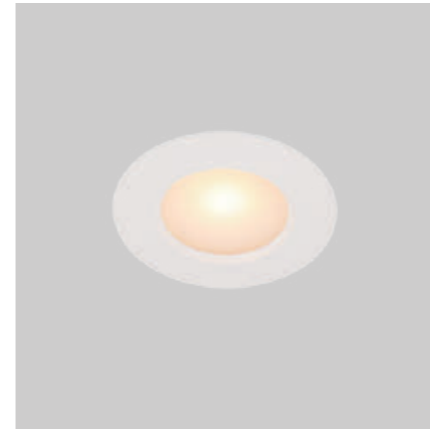

DL0130

Power :1X3W/350mA/Max.10V
 CCT :2700/3000/4000K
 Flux :340lm
 CRI :≥92/85
 Cutout :ø50mm

Beam angle :
 24° 36° 60°

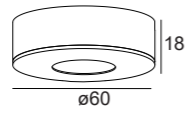

DL0129

Power :1X3W/350mA/Max.10V
 CCT :2700/3000/4000K
 Flux :340lm
 CRI :≥92/85
 Cutout :N/A

Beam angle :
 24° 36° 60°



DL0731

Power :1X3W/DC24V
 CCT :2700/3000/4000K
 Flux :260lm
 CRI :≥85
 Cutout :ø50mm

Beam angle :
 24° 36° 60°



DL0732

Power :1X3W/DC24V
 CCT :2700/3000/4000K
 Flux :260lm
 CRI :≥85
 Cutout :N/A

Beam angle :
 24° 36° 60°

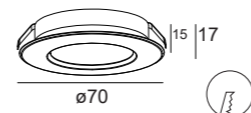

DL1158

Power :1X3W/350mA/Max.10V
 CCT :2700/3000/4000K
 Flux :260lm
 CRI :≥92
 Cutout :ø60mm

Beam angle :N/A

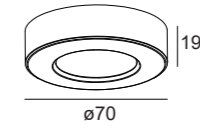

DL1217

Power :1X3W/350mA/Max.10V
 CCT :2700/3000/4000K
 Flux :260lm
 CRI :≥92
 Cutout :N/A

Beam angle :N/A



DOT

COLOR: TW TB BV

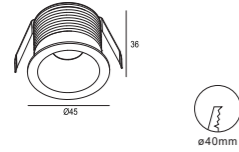

DL1468

Power :1X3W/350mA/Max.10V
CCT :2700/3000/4000K
Flux :240lm
CRI :≥92
Cutout :ø40mm

Beam angle :

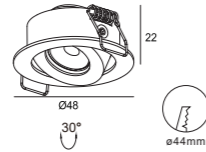
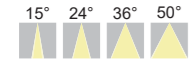

DL1469

Power :1X3W/350mA/Max.10V
CCT :2700/3000/4000K
Flux :240lm
CRI :≥92
Cutout :ø44mm

Beam angle :

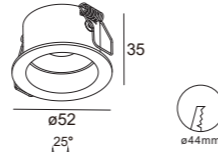
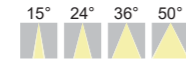

DL1470

Power :1X3W/350mA/Max.10V
CCT :2700/3000/4000K
Flux :240lm
CRI :≥92/85
Cutout :ø44mm

Beam angle :



ALFA

COLOR: TW TB

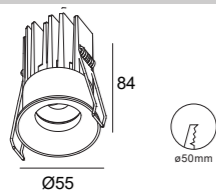
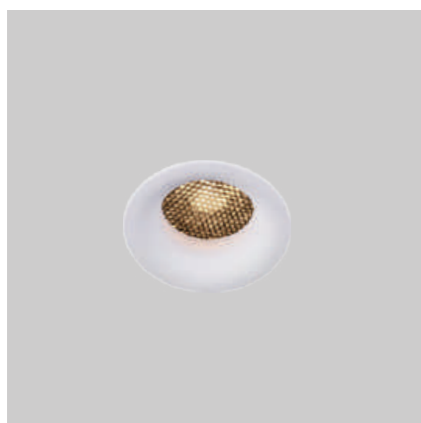

DL1450

Power :1X10W/500mA/Max.19V
 CCT :2700/3000/4000K
 Flux :580lm/960lm
 CRI :≥92
 Cutout :ø50mm

Beam angle :
 10° 15° 24° 36° 50°

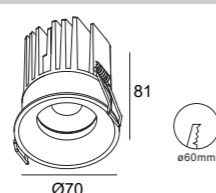

DL1159

Power :1X13W/350mA/Max.37V
 CCT :2700/3000/4000K
 Flux :1180lm
 CRI :≥92
 Cutout :ø60mm

Beam angle :
 10° 15° 24° 36° 50°

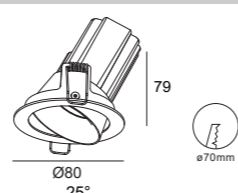

DL1462

Power :1X7W/350mA/Max.19V
 1X10W/500mA/Max.19V
 CCT :2700/3000/4000K
 Flux :580lm/960lm
 CRI :≥92
 Cutout :ø70mm

Beam angle :
 10° 15° 24° 36° 50°



ALFA

COLOR: TW TB

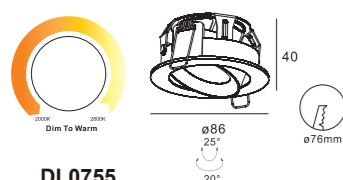

DL0755

Power :1X7W/350mA/Max.19V
 CCT :2000K-2800K
 Flux :580lm
 CRI :≥92
 Cutout :Ø76mm

Beam angle :
 24° 36° 60°

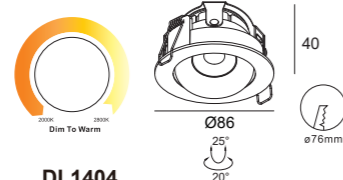

DL1404

Power :1X7W/350mA/Max.19V
 CCT :2000K-2800K
 Flux :580lm
 CRI :≥92
 Cutout :Ø76mm

Beam angle :
 10° 15° 24° 36° 50°

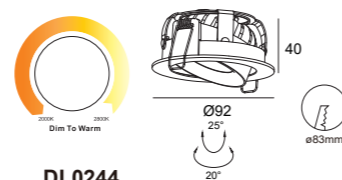

DL0244

Power :1X7W/350mA/Max.19V
 CCT :2000K-2800K
 Flux :580lm
 CRI :≥92
 Cutout :Ø83mm

Beam angle :
 15° 24° 38° 50°



ALFA

COLOR: TW TB

LED CEILING RECESSED

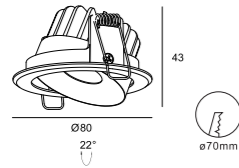

DL0108

Power :1X7W/350mA/Max.19V
 CCT :2700/3000/4000K
 Flux :630lm
 CRI :≥92
 Cutout :ø70mm

Beam angle :

24° 36° 60°

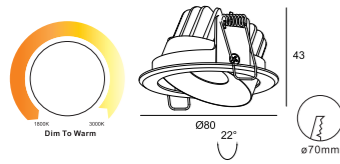

DL0214

Power :1X7W/350mA/Max.19V
 CCT :1800-3000K
 Flux :550lm
 CRI :≥90
 Cutout :ø70mm

Beam angle :

24° 36° 60°

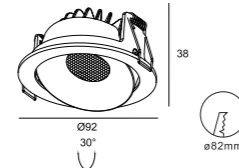

DL0007

Power :1X7W/350mA/Max.19V
 CCT :2700/3000/4000K
 Flux :630lm
 CRI :≥92
 Cutout :ø82mm

Beam angle :

15° 24° 36°

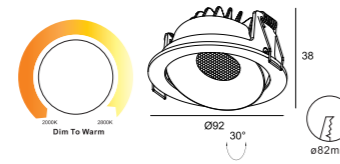

DL0353

Power :1X7W/350mA/Max.19V
 CCT :1800-3000K
 Flux :550lm
 CRI :≥90
 Cutout :ø82mm

Beam angle :

15° 24° 36°

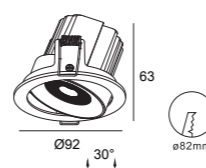

DL1056

Power :1X10W/500mA/Max.19V
 CCT :2700/3000/4000K
 Flux :900lm
 CRI :≥92/85
 Cutout :ø82mm

Beam angle :

15° 24° 36° 55°

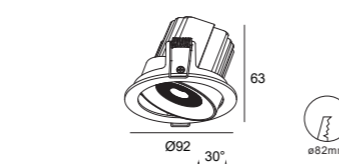

DL1038

Power :1X13W/350mA/Max.37V
 CCT :2700/3000/4000K
 Flux :1250lm
 CRI :≥92/85
 Cutout :ø82mm

Beam angle :

15° 24° 36° 55°

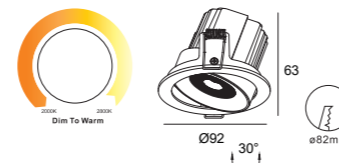

DL0287

Power :1X12W/350mA/Max.37V
 CCT :1800-3000K
 Flux :900lm
 CRI :≥90
 Cutout :ø82mm

Beam angle :

15° 24° 36° 55°

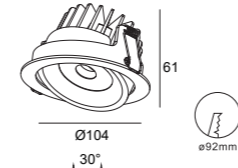

DL1142

Power :1X13W/350mA/Max.37V
 CCT :2700/3000/4000K
 Flux :1300lm
 CRI :≥92
 Cutout :ø92mm

Beam angle :

15° 24° 36° 55°

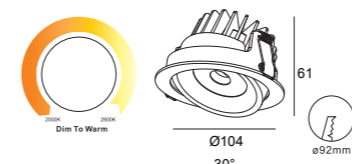

DL0228

Power :1X12W/350mA/Max.37V
 CCT :1800-3000K
 Flux :900lm
 CRI :≥90
 Cutout :ø92mm

Beam angle :

15° 24° 36° 55°



GU10

COLOR: TW TB

GU10 FIXTURE

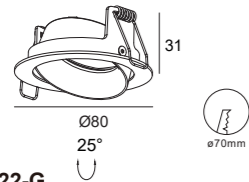

DL0122-G
Gu10/Mr16 Downlight
Cutout :ø70mm
Optional :ALDL1401
ALDL1373

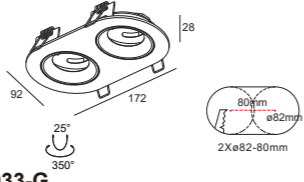

DL0033-G
Gu10/Mr16 Downlight
Cutout :2Xø82-80mm
Optional :ALDL1401
ALDL1373

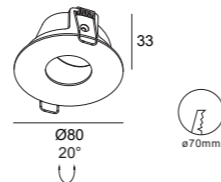

DH0104
Gu10/Mr16 Downlight
Cutout :ø70mm
Optional :ALDL1401
ALDL1373

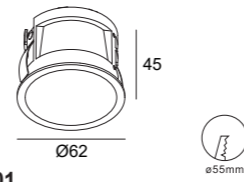

DH0101
Gu10/Mr16 Downlight
Cutout :ø55mm
Optional :ALDL1401
ALDL1373
ALDL1022

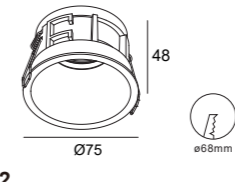

DH0092
Gu10/Mr16 Downlight
Cutout :ø68mm
Optional :ALDL1401
ALDL1373
ALDL1022

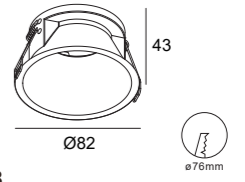

DH0048
Gu10/Mr16 Downlight
Cutout :ø76mm
Optional :ALDL1401
ALDL1373
ALDL1022

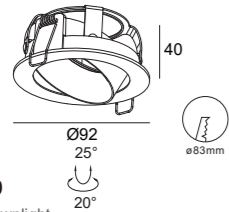
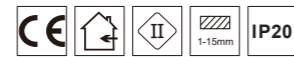

DH0109
Gu10/Mr16 Downlight
Cutout :ø83mm
Optional :N/A

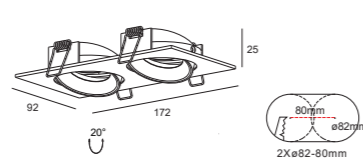

DL0031-G
Gu10/Mr16 Downlight
Cutout :2Xø82-80mm
Optional :ALDL1401
ALDL1373

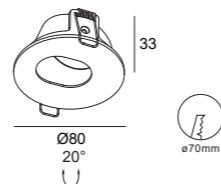

DH0105
Gu10/Mr16 Downlight
Cutout :ø70mm
Optional :ALDL1401
ALDL1373

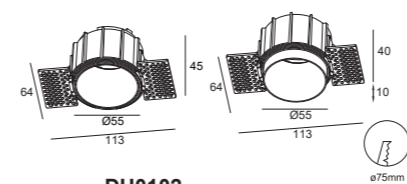

DH0102
Gu10/Mr16 Downlight
Cutout :ø75mm
Optional :ALDL1401
ALDL1373
ALDL1022

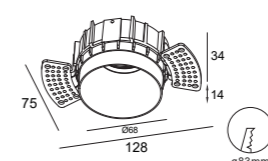
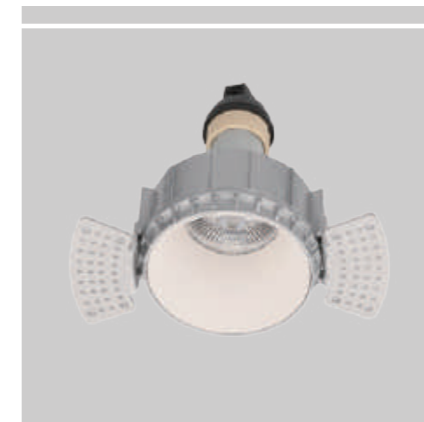

DH0088
Gu10/Mr16 Downlight
Cutout :ø83mm
Optional :ALDL1401
ALDL1373
ALDL1022

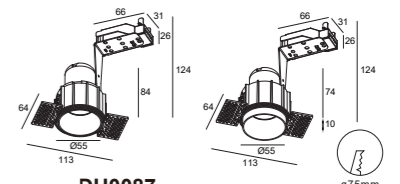

DH0087
E27 Downlight
Cutout :ø75mm



GU10

COLOR: TW TB

GU10 FIXTURE

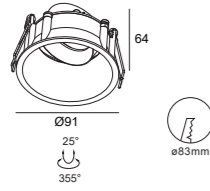

DH0106
Gu10/Mr16 Downlight
Cutout :Ø83mm
Optional :ALDL1401
ALDL1373
ALDL1022

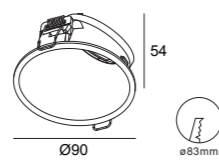

DH0110
Gu10/Mr16 Downlight
Cutout :Ø83mm
Optional :ALDL1401
ALDL1373
ALDL1022

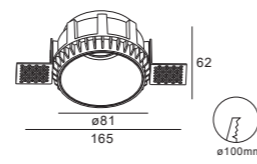
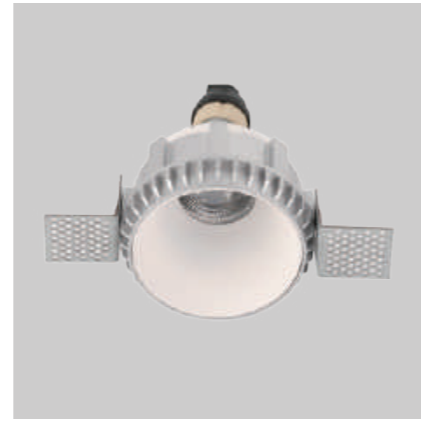

DL0177-G
Gu10/Mr16 Downlight
Cutout :Ø100mm
Optional :ALDL1401
ALDL1373
ALDL1022

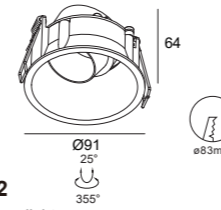

DH0052
Gu10/Mr16 Downlight
Cutout :Ø83mm
Optional :ALDL1401
ALDL1373
ALDL1022

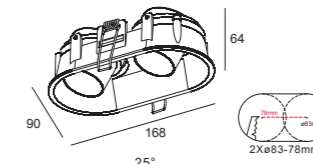

DH0053
Gu10/Mr16 Downlight
Cutout :2xØ83-78mm
Optional :ALDL1401
ALDL1373
ALDL1022

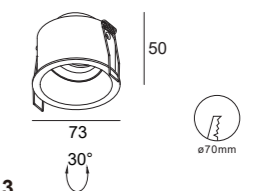

DH0113
Gu10/Mr16 Downlight
Cutout :Ø70mm
Optional :ALDL1401
ALDL1373
ALDL1022

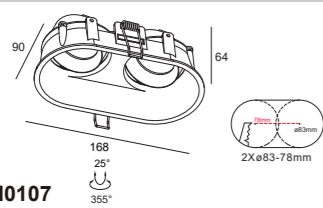
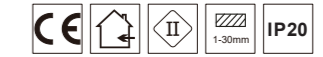

DH0107
Gu10/Mr16 Downlight
Cutout :2xØ83-78mm
Optional :ALDL1401
ALDL1373
ALDL1022

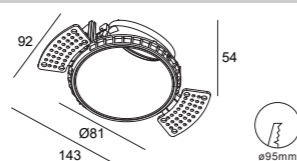

DH0111
Gu10/Mr16 Downlight
Cutout :Ø95mm
Optional :ALDL1401
ALDL1373
ALDL1022

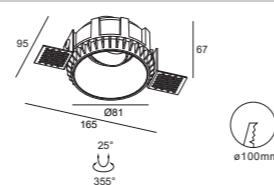

DH0039
Gu10/Mr16 Downlight
Cutout :Ø100mm
Optional :ALDL1401
ALDL1373
ALDL1022

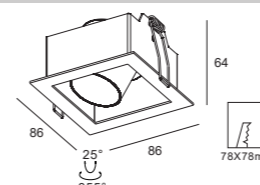

DH0054
Gu10/Mr16 Downlight
Cutout :78x78mm
Optional :ALDL1401
ALDL1373
ALDL1022

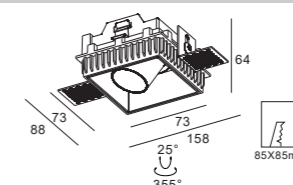

DH0058
Gu10/Mr16 Downlight
Cutout :85x85mm
Optional :ALDL1401
ALDL1373
ALDL1022

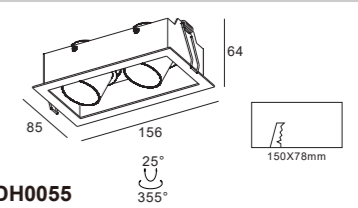

DH0055
Gu10/Mr16 Downlight
Cutout :150x78mm
Optional :ALDL1401
ALDL1373
ALDL1022



GU10

COLOR: TW TB

GU10 FIXTURE

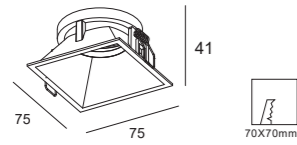
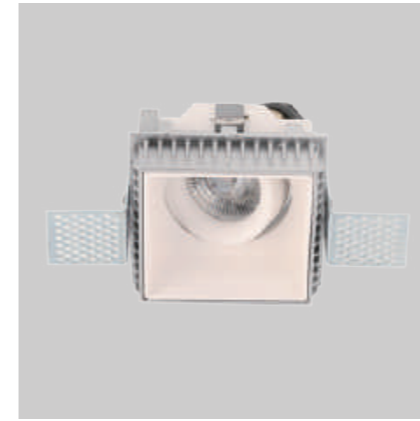
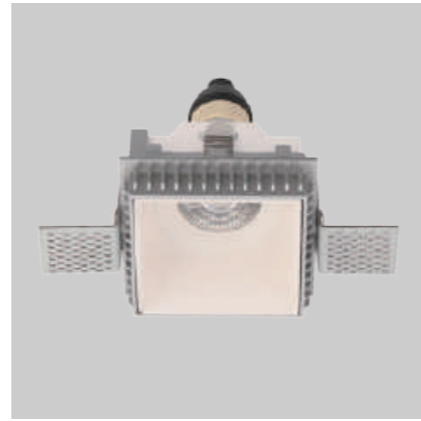

DH0089
Gu10/Mr16 Downlight
Cutout :70X70mm
Optional :ALDL1401
ALDL1373
ALDL1022

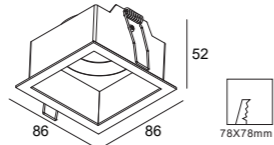

DL0014-G
Gu10/Mr16 Downlight
Cutout :78X78mm
Optional :ALDL1401
ALDL1373
ALDL1022

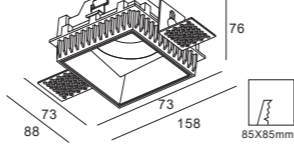

DL0176-G
Gu10/Mr16 Downlight
Cutout :85X85mm
Optional :ALDL1401
ALDL1373
ALDL1022

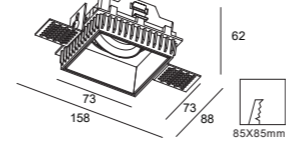

DH0035
Gu10/Mr16 Downlight
Cutout :85X85mm
Optional :ALDL1401
ALDL1373
ALDL1022

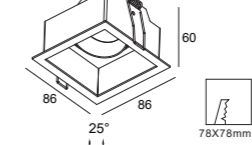

DH0112
Gu10/Mr16 Downlight
Cutout :150X78mm
Optional :ALDL1401
ALDL1373
ALDL1022

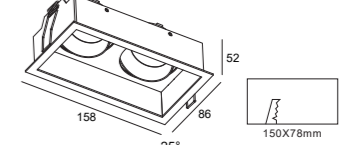

DH0050
Gu10/Mr16 Downlight
Cutout :150X78mm
Optional :ALDL1401
ALDL1373
ALDL1022

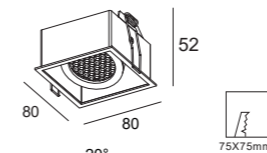
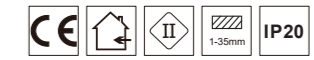

DH0091
Gu10/Mr16 Downlight
Cutout :75X75mm

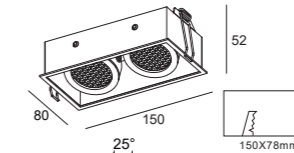
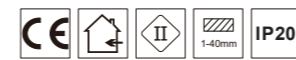

DH0094
Gu10/Mr16 Downlight
Cutout :150X78mm



GU10

COLOR: TW TB

LED CEILING SURFACE

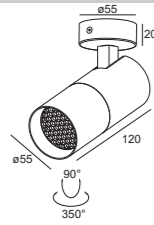

CH0131
Gu 10 Ceiling Surface Light

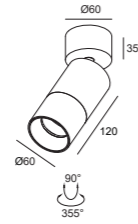

CH0201
Gu 10 Ceiling Surface Light

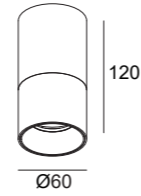

CH0202
Gu10/Mr16 Downlight

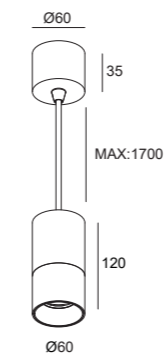

PH0034
Gu10/Mr16 Downlight

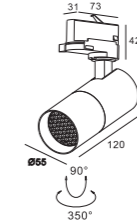

TR0073
Gu 10 Track Light

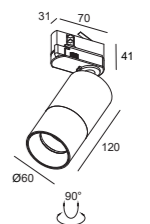

TR0164
Gu 10 Track Light



GU10

COLOR: TW TB

LED CEILING SURFACE

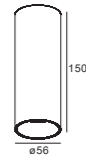

CH0100
Gu10 Ceiling Surface Light
CE, I, IP20

CH0101
Gu10 Ceiling Surface Light
CE, I, IP20

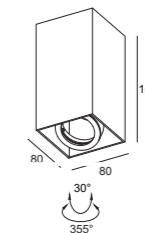
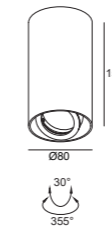

CH0178
Gu10/Mr16 Downlight
CE, I, IP20

CH0179
Gu10/Mr16 Downlight
CE, I, IP20

SOLAR

COLOR: TW TB

SOLAR MODULE

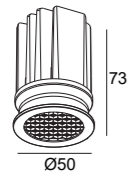

DL1373

Power :1X7W/350mA/Max.19V
:1X10W/500mA/Max.19V
CCT :2700/3000/4000K
Flux :630lm/860lm
CRI :≥92

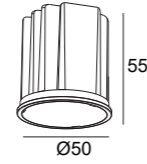
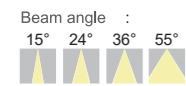

DL1401

Power :1X7W/350mA/Max.19V
:1X10W/500mA/Max.19V
CCT :2700/3000/4000K
Flux :630lm/860lm
CRI :≥92

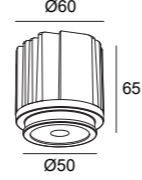
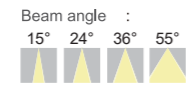

DL1022

Power :1X13W/350mA/Max.37V
CCT :2700/3000/4000K
Flux :1180lm
CRI :≥92

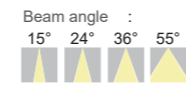

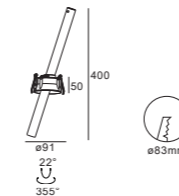

DL0557

Power :1X7W/350mA/Max.19V
 CCT :2700/3000/4000K
 Flux :595lm
 CRI :≥92
 Cutout :ø83mm

Beam angle :
 35° 50°

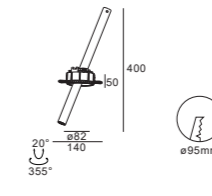

DL0105

Power :1X7W/350mA/Max.19V
 CCT :2700/3000/4000K
 Flux :595lm
 CRI :≥92
 Cutout :ø95mm

Beam angle :
 35° 50°

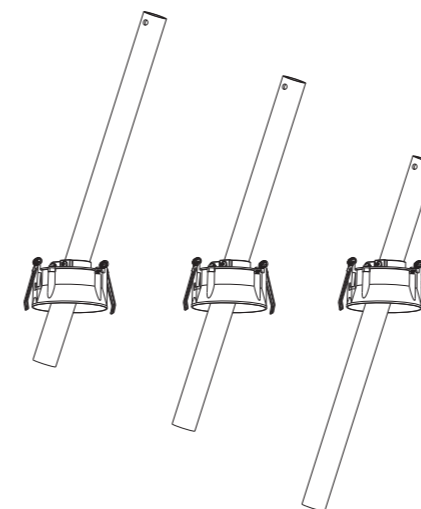

ROBO

COLOR: TW TB

LED CEILING RECESSED

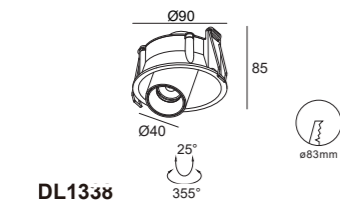
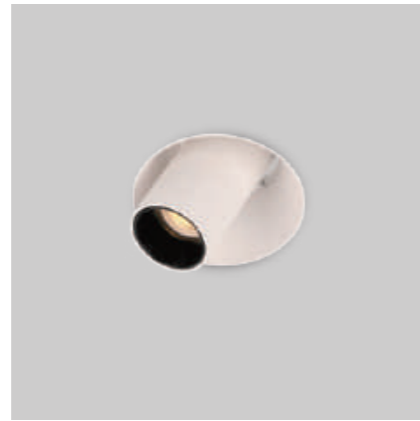

DL1338
 Power :1X7W/350mA/Max.19V
 CCT :2700/3000/4000K
 Flux :630lm
 CRI :≥92
 Cutout :ø83mm

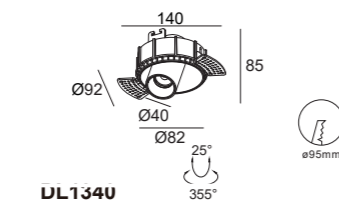
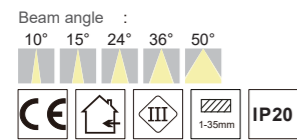

DL1340
 Power :1X7W/350mA/Max.19V
 CCT :2700/3000/4000K
 Flux :630lm
 CRI :≥92
 Cutout :ø95mm

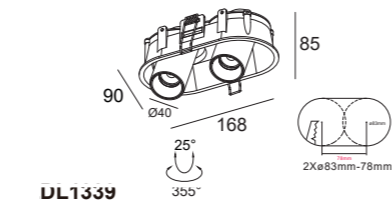
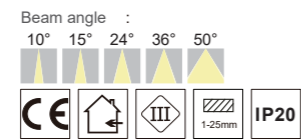

DL1339
 Power :2X7W/350mA/2XMax.19V
 CCT :2700/3000/4000K
 Flux :2X630lm
 CRI :≥92
 Cutout :2Xø83-78mm

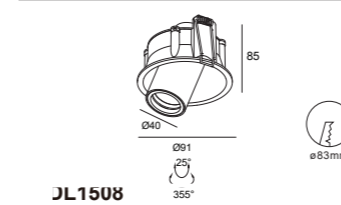
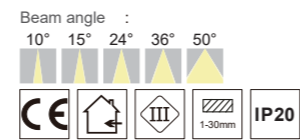

JL1508
 Power :1X7W/350mA/Max.19V
 CCT :2700/3000/4000K
 Flux :630lm
 CRI :≥92
 Cutout :ø83mm

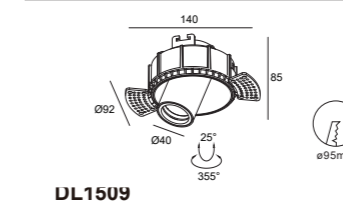

DL1509
 Power :1X7W/350mA/Max.19V
 CCT :2700/3000/4000K
 Flux :630lm
 CRI :≥92
 Cutout :ø95mm

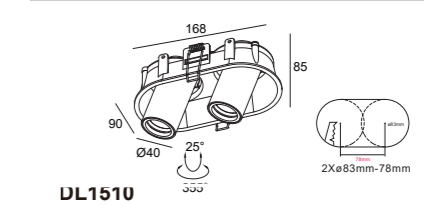

DL1510
 Power :2X7W/350mA/2XMax.19V
 CCT :2700/3000/4000K
 Flux :2X630lm
 CRI :≥92
 Cutout :2Xø83-78mm



ROBO

COLOR: TW TB

LED CEILING RECESSED

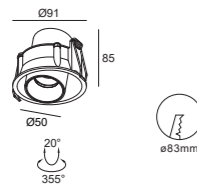
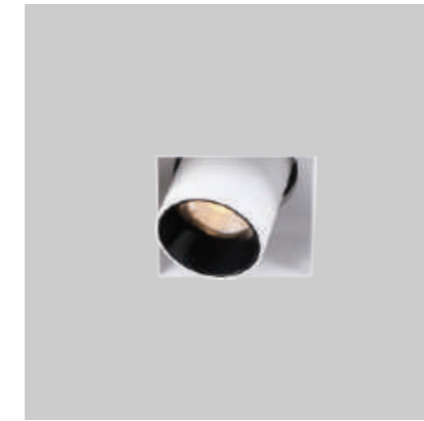
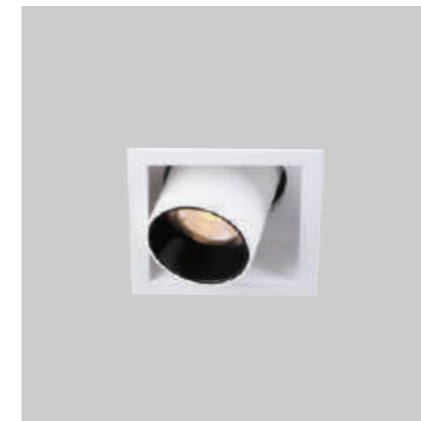
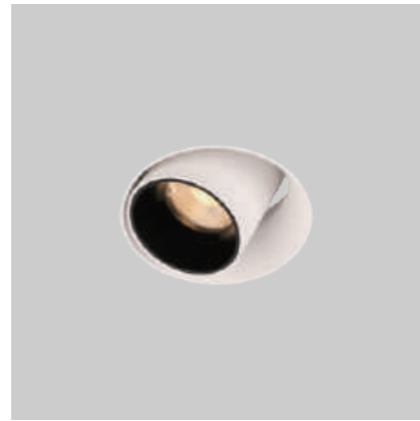
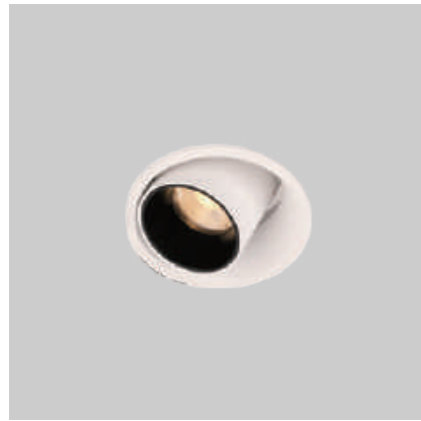

DL1057

Power :1X13W/350mA/Max.37V
 CCT :2700/3000/4000K
 Flux :1200lm
 CRI :≥92
 Cutout :ø83mm

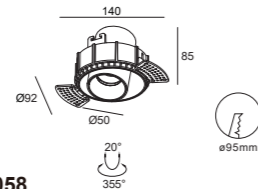
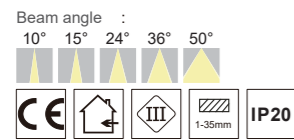

DL1058

Power :1X13W/350mA/Max.37V
 CCT :2700/3000/4000K
 Flux :1200lm
 CRI :≥92
 Cutout :ø95mm

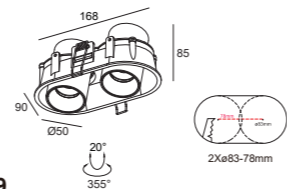
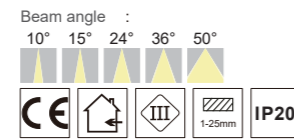

DL1059

Power :2X13W/350mA/2XMax.37V
 CCT :2700/3000/4000K
 Flux :2X1200lm
 CRI :≥92
 Cutout :2Xø83-78mm

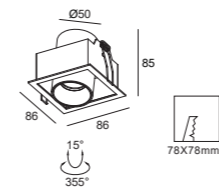
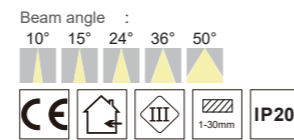

DL1094

Power :1X13W/350mA/Max.37V
 CCT :2700/3000/4000K
 Flux :1200lm
 CRI :≥92
 Cutout :78X78mm

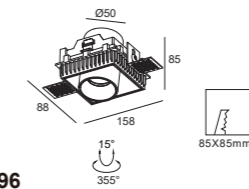
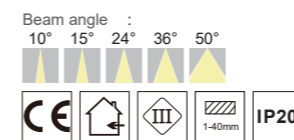

DL1096

Power :1X13W/350mA/Max.37V
 CCT :2700/3000/4000K
 Flux :1200lm
 CRI :≥92
 Cutout :85X85mm

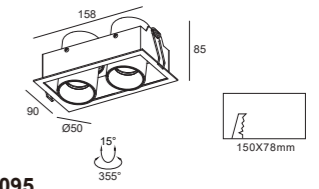
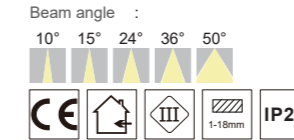

DL1095

Power :2X13W/350mA/2XMax.37V
 CCT :2700/3000/4000K
 Flux :2X1200lm
 CRI :≥92
 Cutout :150X78mm

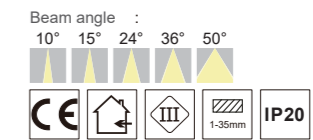

ROBO - ZOOM

COLOR: TW TB

LED CEILING RECESSED

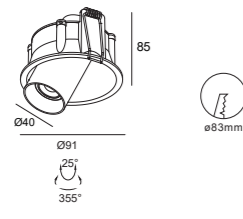
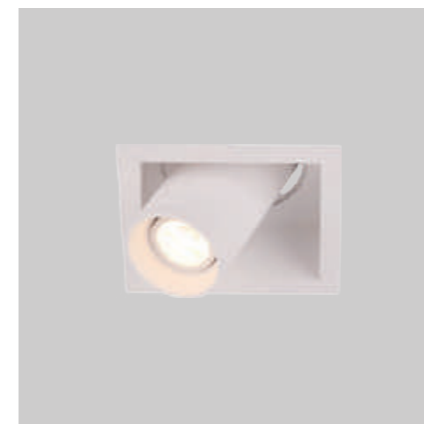

DL1502

Power :1X7W/350mA/Max.19V
 CCT :2700/3000/4000K
 Flux :630lm
 CRI :≥92
 Cutout :ø83mm

Beam angle :
 6-60°

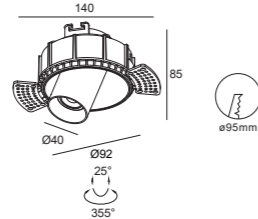

DL1503

Power :1X7W/350mA/Max.19V
 CCT :2700/3000/4000K
 Flux :630lm
 CRI :≥92
 Cutout : Ø95mm

Beam angle :
 6-60°

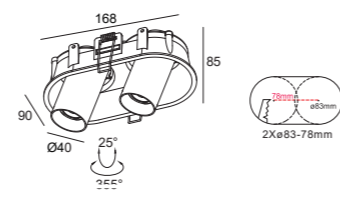

DL1504

Power :2X7W/350mA/2XMax.19V
 CCT :2700/3000/4000K
 Flux :2X630lm
 CRI :≥92
 Cutout : 2XØ83-78mm

Beam angle :
 6-60°

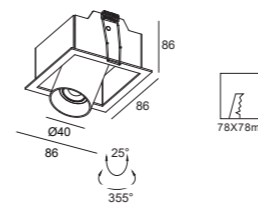

DL1505

Power :1X7W/350mA/Max.19V
 CCT :2700/3000/4000K
 Flux :630lm
 CRI :≥92
 Cutout :78X78mm

Beam angle :
 6-60°

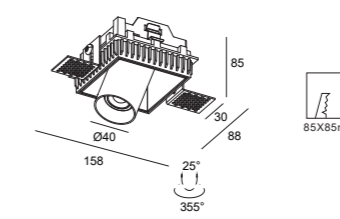

DL1506

Power :1X7W/350mA/Max.19V
 CCT :2700/3000/4000K
 Flux :630lm
 CRI :≥92
 Cutout :85X85mm

Beam angle :
 6-60°

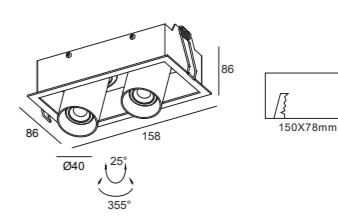

DL1507

Power :2X7W/350mA/2XMax.19V
 CCT :2700/3000/4000K
 Flux :2X630lm
 CRI :≥92
 Cutout : 150X78mm

Beam angle :
 6-60°



ROBO - ZOOM

COLOR: TW TB

LED CEILING RECESSED

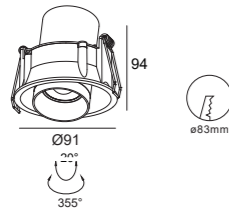

DL0800

Power :1X13W/350mA/Max.37V
 CCT :2700/3000/4000K
 Flux :1180lm
 CRI :≥92
 Cutout :ø83mm

Beam angle : 15-55°

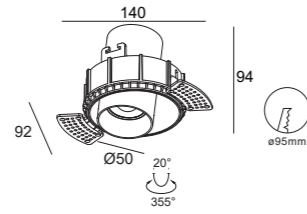

DL1343

Power :1X13W/350mA/Max.37V
 CCT :2700/3000/4000K
 Flux :1180lm
 CRI :≥92
 Cutout :ø95mm

Beam angle : 15-55°

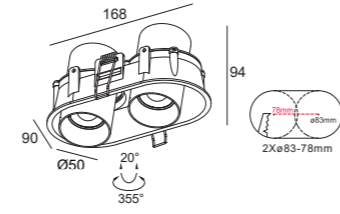

DL1342

Power :2X13W/350mA/2XMax.37V
 CCT :2700/3000/4000K
 Flux :2X1180lm
 CRI :≥92
 Cutout :2Xø83-78mm

Beam angle : 15-55°

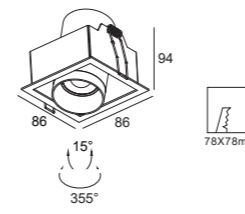

DL1211

Power :1X13W/350mA/Max.37V
 CCT :2700/3000/4000K
 Flux :1180lm
 CRI :≥92
 Cutout :78X78mm

Beam angle : 15-55°

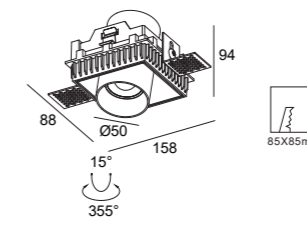

DL1346

Power :1X13W/350mA/Max.37V
 CCT :2700/3000/4000K
 Flux :1180lm
 CRI :≥92
 Cutout :85X85mm

Beam angle : 15-55°

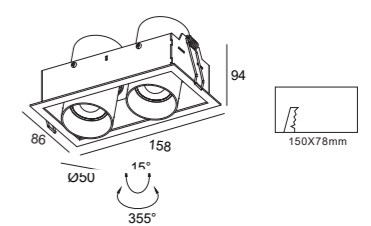

DL1345

Power :2X13W/350mA/2XMax.37V
 CCT :2700/3000/4000K
 Flux :2X1180lm
 CRI :≥92
 Cutout :150X78mm

Beam angle : 15-55°



15°

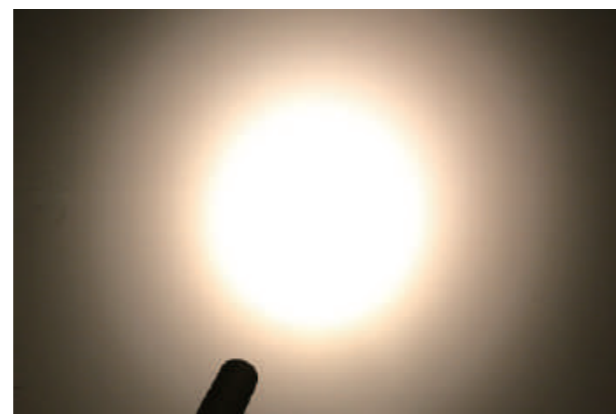

55°

ROBO

COLOR: MW MB AB BC CP RG AG GL

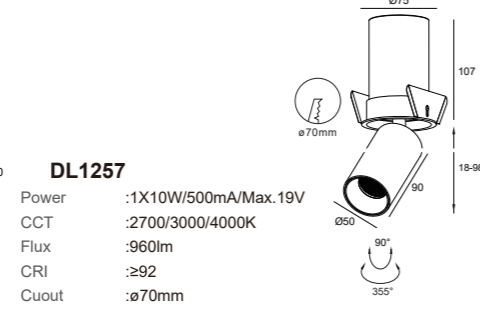
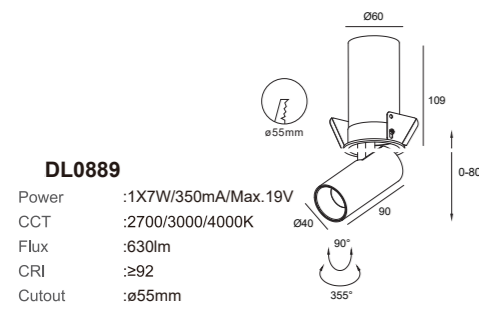

Beam angle :
 24° 36° 60°

CE, Home, III, >2mm, IP20

Beam angle :
 10° 15° 24° 36° 50°

CE, Home, III, >10mm, IP20

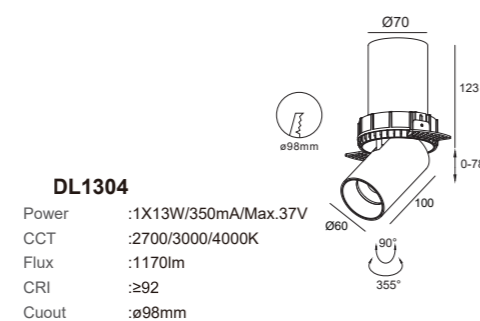
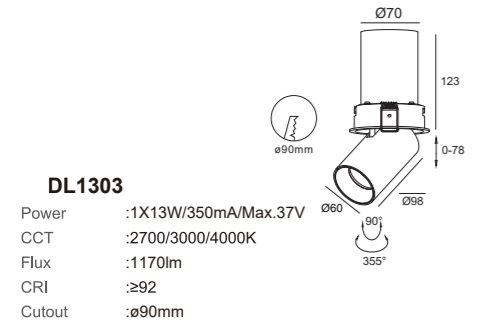

Beam angle :
 10° 15° 24° 36° 50°

CE, Home, III, 1-15mm, IP20

Beam angle :
 10° 15° 24° 36° 50°

CE, Home, III, 1-25mm, IP20

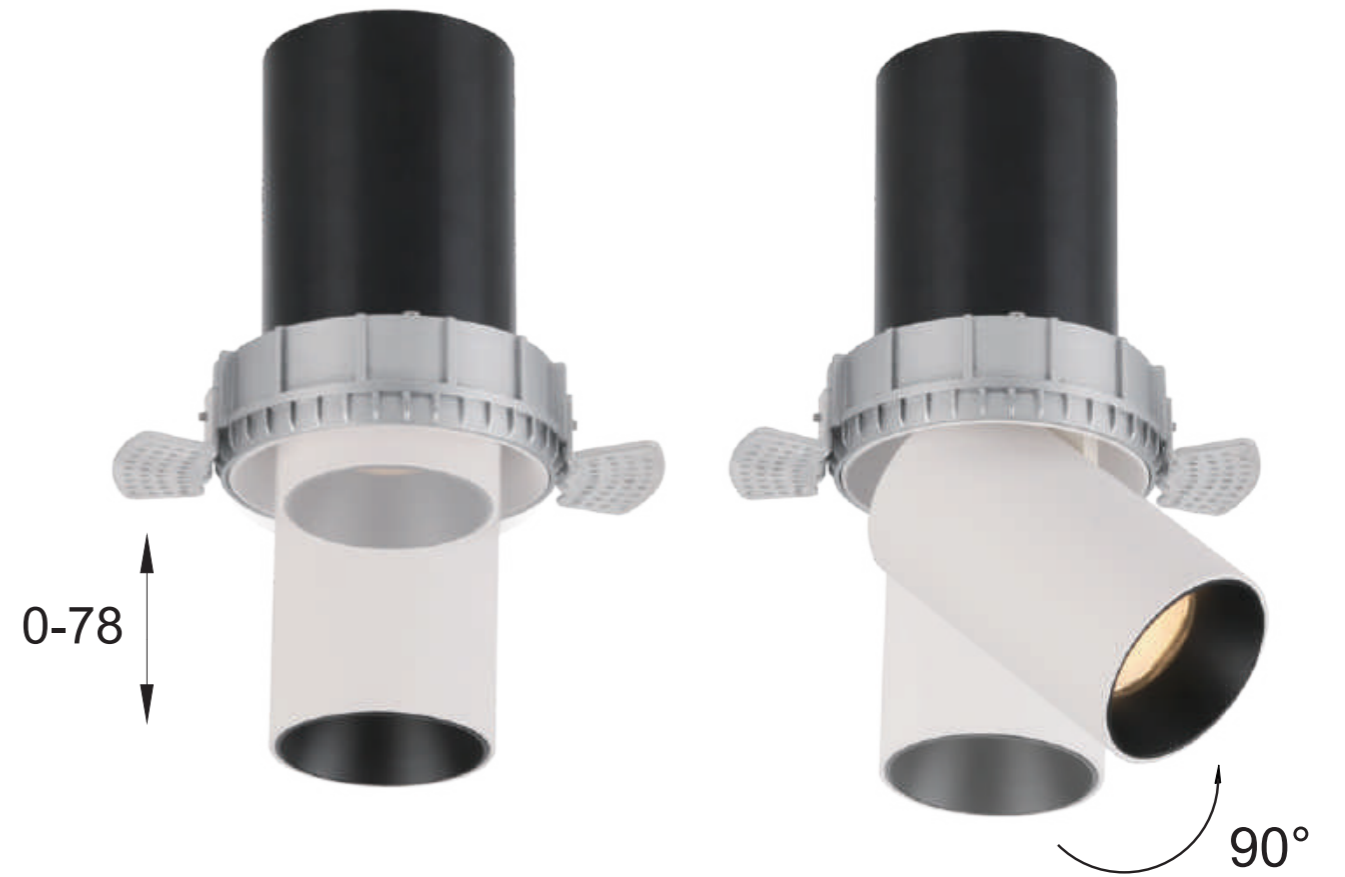

Accessories :

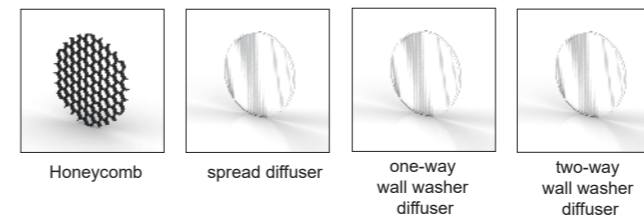

Reflector :



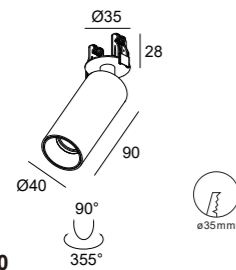

DL1280
 Power :1X7W/350mA/Max.19V
 CCT :2700/3000/4000K
 Flux :630lm
 CRI :≥92
 Cutout :ø35mm

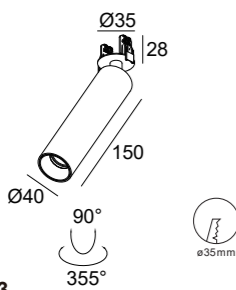
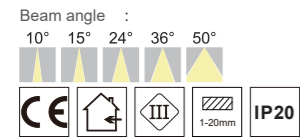

DL1283
 Power :1X7W/350mA/Max.19V
 CCT :2700/3000/4000K
 Flux :630lm
 CRI :≥92
 Cutout :ø35mm

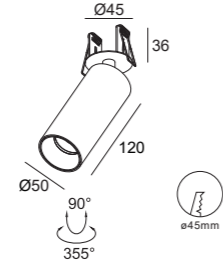
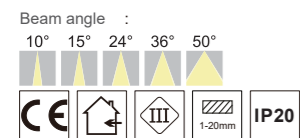

DL1281
 Power :1X10W/500mA/Max.19V
 CCT :2700/3000/4000K
 Flux :960lm
 CRI :≥92
 Cuout :ø45mm

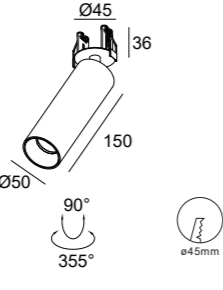
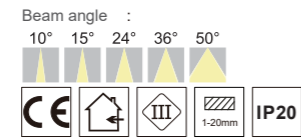

DL1284
 Power :1X10W/500mA/Max.19V
 CCT :2700/3000/4000K
 Flux :960lm
 CRI :≥92
 Cuout :ø45mm

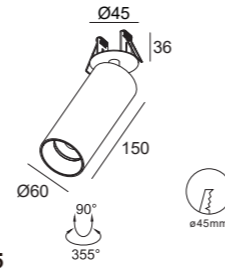
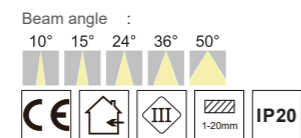

DL1285
 Power :1X18W/500mA/Max.37V
 CCT :2700/3000/4000K
 Flux :1700m
 CRI :≥92
 Cutout :ø45mm

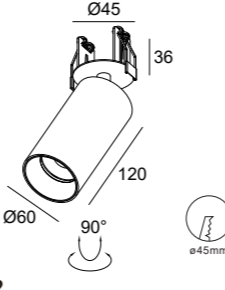
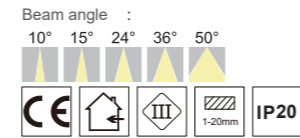

DL1282
 Power :1X18W/500mA/Max.37V
 CCT :2700/3000/4000K
 Flux :1700m
 CRI :≥92
 Cutout :ø45mm

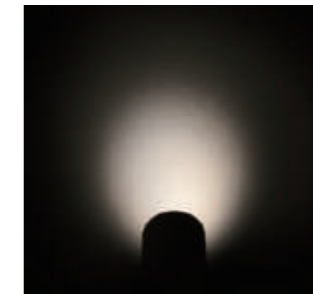
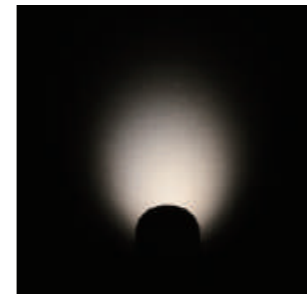
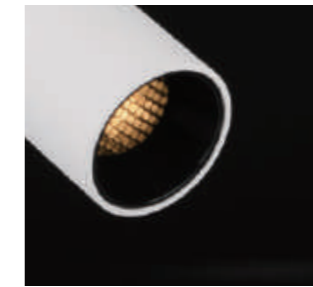
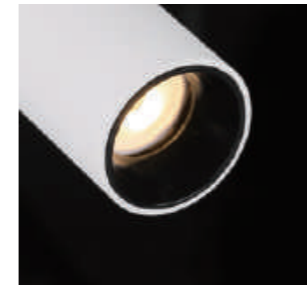
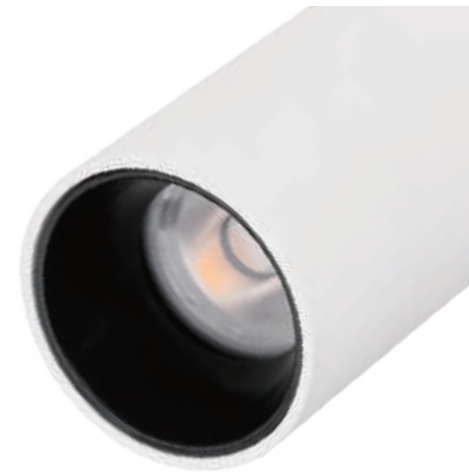
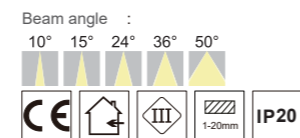

FINISH



Accessories:

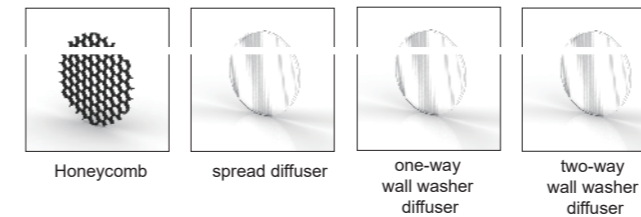

Reflector:



ROBO

COLOR: MW MB AB BC CP RG AG GL

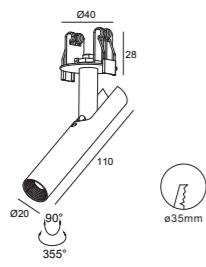

DL1382

Power :1X2W/700mA/Max.3V
 CCT :2700/3000/4000K
 Flux :180lm
 CRI :≥92
 Cutout :ø35mm

Beam angle :
 15° 24° 36° 60°

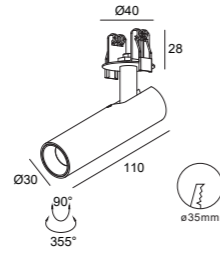

DL1383

Power :1X2W/700mA/Max.3V
 CCT :2700/3000/4000K
 Flux :360lm
 CRI :≥92
 Cuout :ø35mm

Beam angle :
 10° 20° 40° 60°

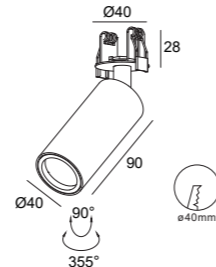

DL1440

Power :1X7W/350mA/Max.19V
 CCT :2700/3000/4000K
 Flux :630lm
 CRI :≥92
 Cuout :ø40mm

Beam angle :
 3°

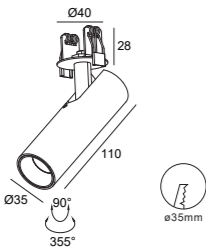

DL1384

Power :1x4W/350mA/Max.11V
 CCT :2700/3000/4000K
 Flux :380lm
 CRI :≥92
 Cutout :ø35mm

Beam angle :
 15° 24° 36° 55°



ROBO

COLOR: MW MB AB BC CP RG AG GL

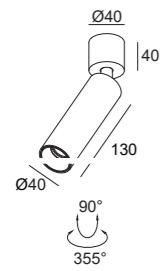

CH0188
 Power :1X8W/AC230v-50Hz
 CCT :2700/3000/4000K
 Flux :730lm
 CRI :≥92

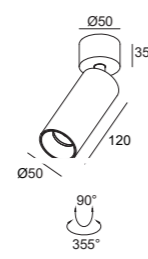
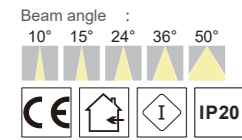

CH0189
 Power :1X8W/AC230v-50Hz
 CCT :2700/3000/4000K
 Flux :730lm
 CRI :≥92

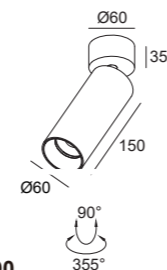
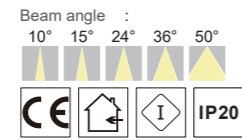

CH0190
 Power :1X15W/AC230v-50Hz
 CCT :2700/3000/4000K
 Flux :1300lm
 CRI :≥92

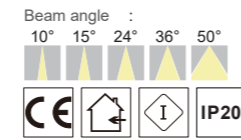

Accessories:

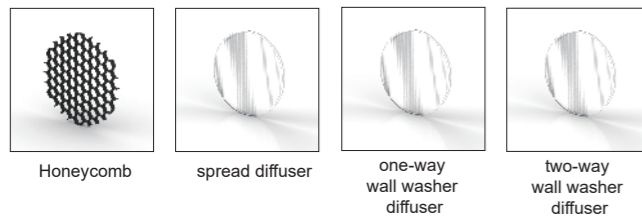

Reflector:



ROBO

COLOR: TW TB



	Power	CCT	Flux	CRI	Optional
DL1495	1X13W/350mA/Max.37V	2700/3000/4000K	1170lm	≥92	200mm
DL1496	1X13W/350mA/Max.37V	2700/3000/4000K	1170lm	≥92	400mm
DL1497	1X13W/350mA/Max.37V	2700/3000/4000K	1170lm	≥92	600mm

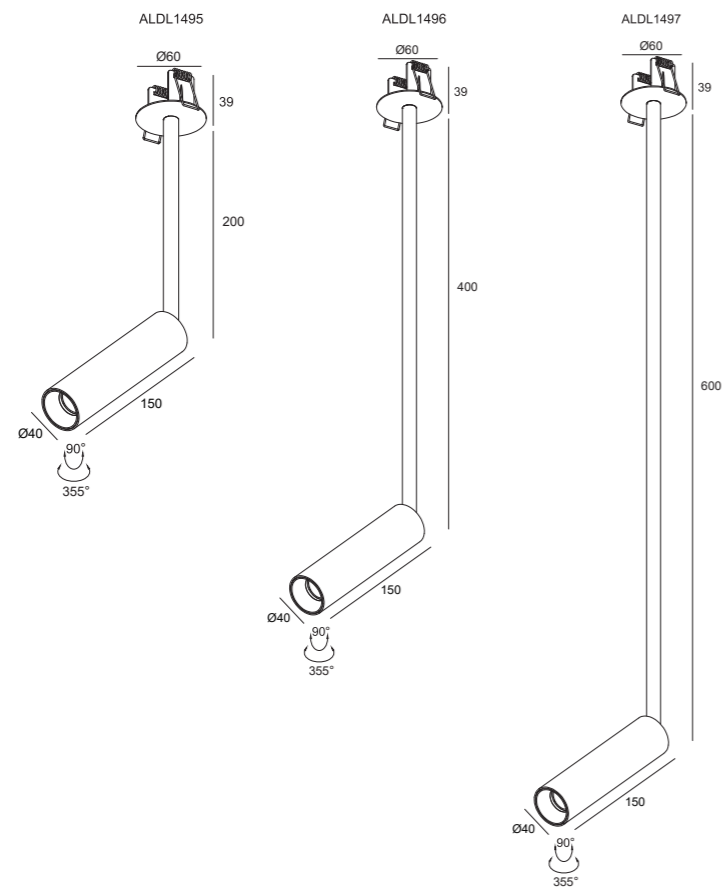
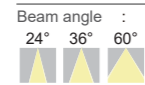

ROBO

LED CEILING RECESSED



	Power	CCT	Flux	CRI	Optional
DL0714	1X13W/350mA/Max.37V	2700/3000/4000K	1170lm	≥92	200mm
DL0715	1X13W/350mA/Max.37V	2700/3000/4000K	1170lm	≥92	400mm
DL0716	1X13W/350mA/Max.37V	2700/3000/4000K	1170lm	≥92	600mm

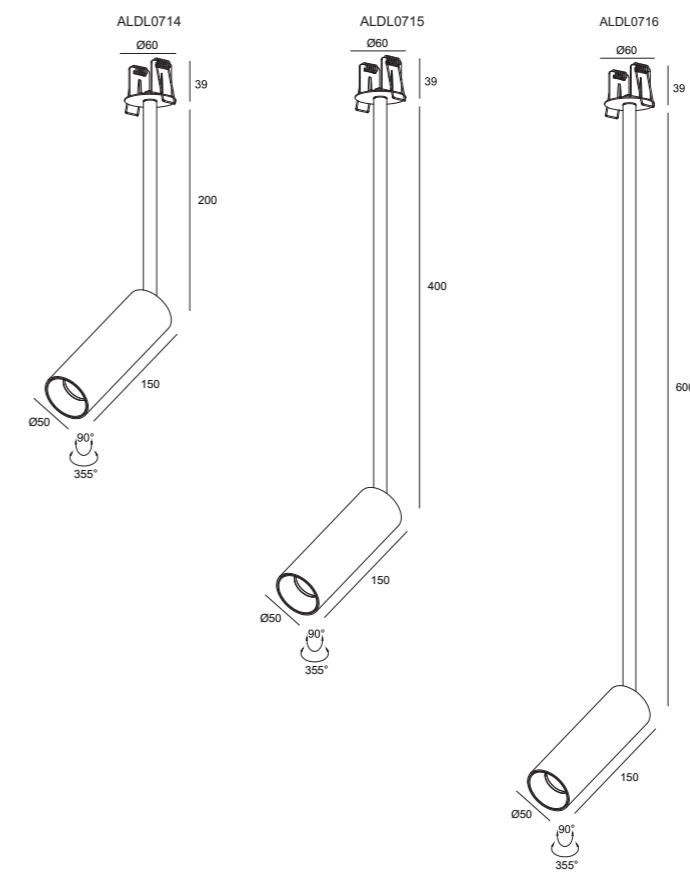
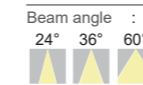

ROBO

COLOR: TW TB

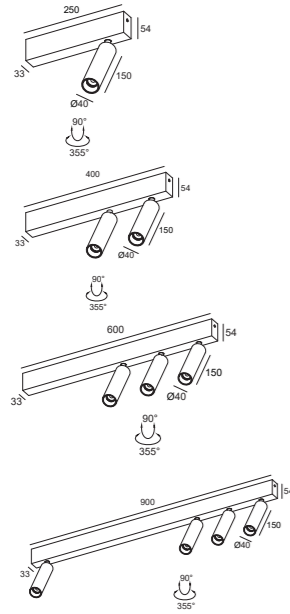

CH0116

Power	CCT	Flux	CRI	Optional
1X15W/AC230V-50Hz	2700/3000/4000K	1300lm	≥92	DALI,PWM,or 1-10V Dimming

CH0117

2X15W/AC230V-50Hz	2700/3000/4000K	2600lm	≥92	DALI,PWM,or 1-10V Dimming
-------------------	-----------------	--------	-----	---------------------------

CH0118

3X15W/AC230V-50Hz	2700/3000/4000K	3900lm	≥92	DALI,PWM,or 1-10V Dimming
-------------------	-----------------	--------	-----	---------------------------

CH0119

4X15W/AC230V-50Hz	2700/3000/4000K	5200lm	≥92	DALI,PWM,or 1-10V Dimming
-------------------	-----------------	--------	-----	---------------------------

Beam angle :
24° 35° 60°



LED CEILING SURFACE

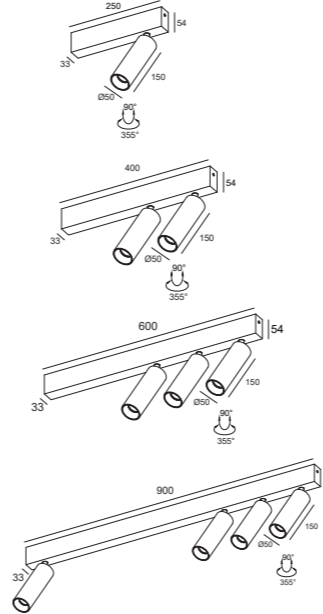

CH0103

Power	CCT	Flux	CRI	Optional
1X15W/AC230V-50Hz	2700/3000/4000K	1300lm	≥92	DALI,PWM,or 1-10V Dimming

CH0104

2X15W/AC230V-50Hz	2700/3000/4000K	2600lm	≥92	DALI,PWM,or 1-10V Dimming
-------------------	-----------------	--------	-----	---------------------------

CH0105

3X15W/AC230V-50Hz	2700/3000/4000K	3900lm	≥92	DALI,PWM,or 1-10V Dimming
-------------------	-----------------	--------	-----	---------------------------

CH0106

4X15W/AC230V-50Hz	2700/3000/4000K	5200lm	≥92	DALI,PWM,or 1-10V Dimming
-------------------	-----------------	--------	-----	---------------------------

Beam angle :
24° 35° 60°

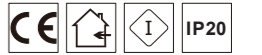

ROBO

COLOR: MW MB AB BC CP RG AG GL

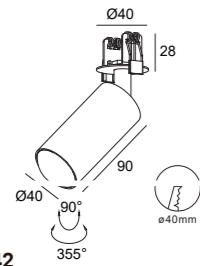

DL1442

Power :1X7W/350mA/Max.19V
 CCT :2700/3000/4000K
 Flux :630lm
 CRI :≥92
 Cutout :ø60mm

Beam angle :N/A

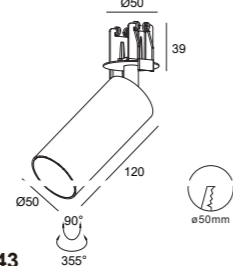

DL1443

Power :1X13W/350mA/Max.37V
 CCT :2700/3000/4000K
 Flux :1180lm
 CRI :≥92
 Cuout :ø70mm

Beam angle :N/A



ROBO

LED CEILING RECESSED

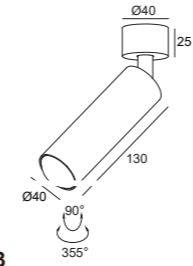

CH0203

Power :1X8W/AC230V-50Hz
 CCT :2700/3000/4000K
 Flux :730lm
 CRI :≥92

Beam angle :N/A

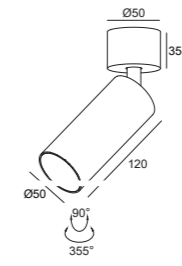

CH0204

Power :1X8W/AC230V-50Hz
 CCT :2700/3000/4000K
 Flux :1180lm
 CRI :≥92

Beam angle :N/A



ROBO

COLOR: TW TB



	Power	CCT	Flux	CRI	Optional
DL1456	1X7W/350mA/Max.37V	2700/3000/4000K	630lm	≥92	241mm
DL1458	1X7W/350mA/Max.37V	2700/3000/4000K	630lm	≥92	441mm
DL1460	1X7W/350mA/Max.37V	2700/3000/4000K	630lm	≥92	641mm

Beam angle :N/A

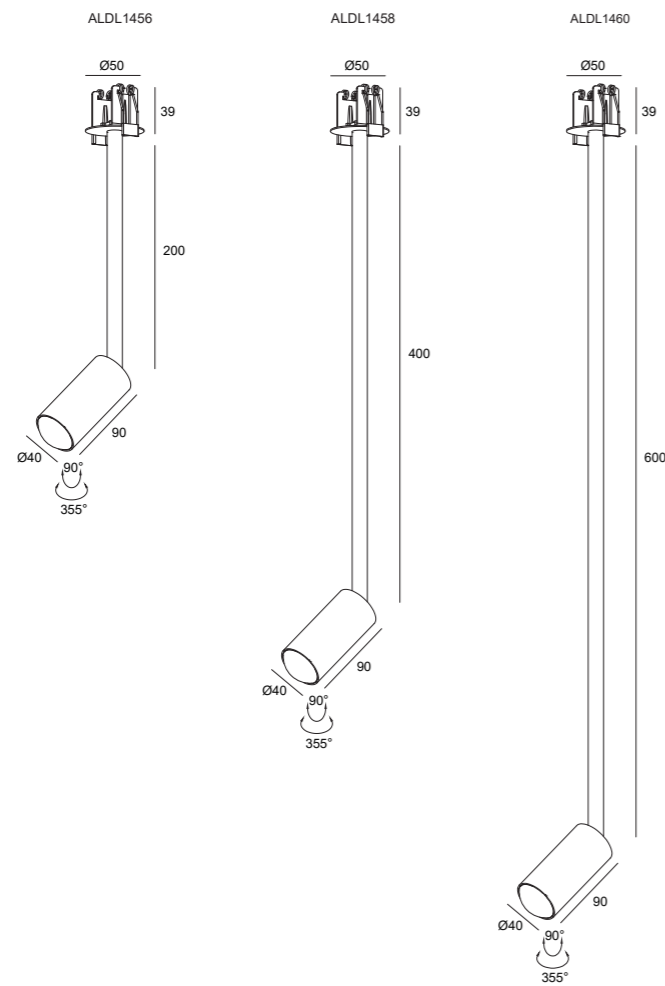
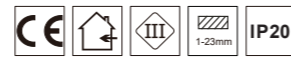

ROBO

LED CEILING RECESSED



	Power	CCT	Flux	CRI	Optional
DL1457	1X13W/350mA/Max.37V	2700/3000/4000K	1170lm	≥92	200mm
DL1459	1X13W/350mA/Max.37V	2700/3000/4000K	1170lm	≥92	400mm
DL1461	1X13W/350mA/Max.37V	2700/3000/4000K	1170lm	≥92	600mm

Beam angle :N/A

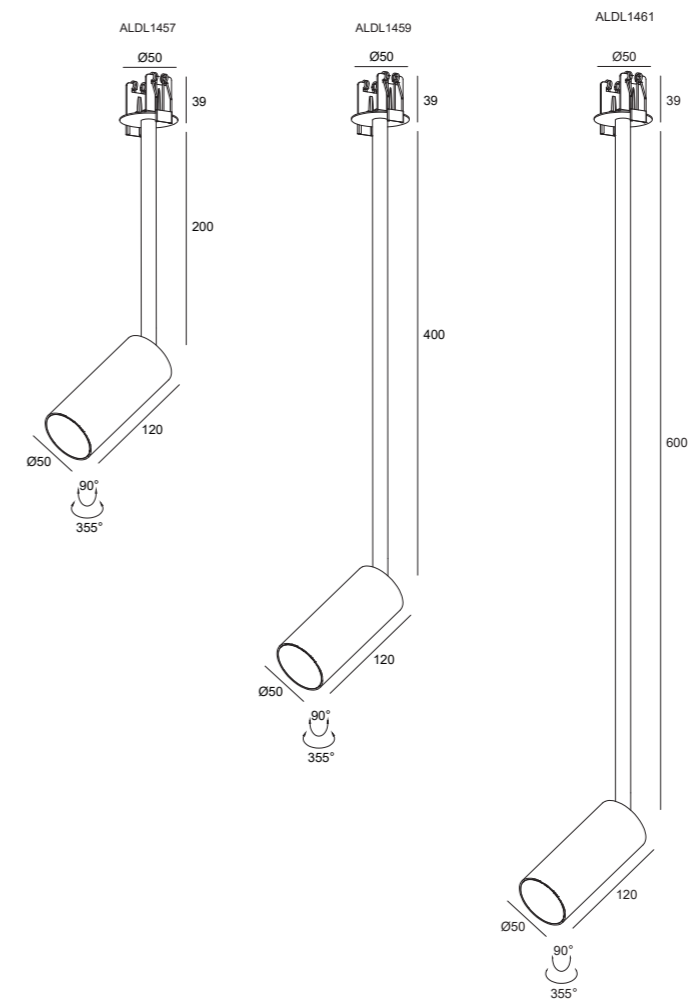

ROBO - ZOOM

COLOR: TW TB

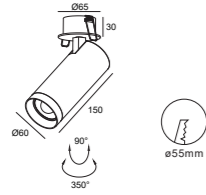

DL1137

Power :1X13W/350mA/Max.37V
 CCT :2700/3000/4000K
 Flux :1160lm
 CRI :≥92
 Cutout :ø55mm

Beam angle :
 15°- 60°

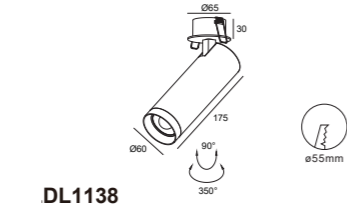

DL1138

Power :1X18W/500mA/Max.37V
 CCT :2700/3000/4000K
 Flux :1620lm
 CRI :≥92/85
 Cutout :ø55mm

Beam angle :
 15°- 60°

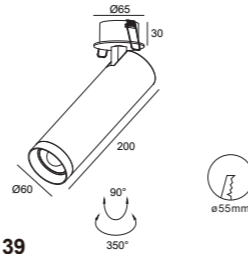

DL1139

Power :1X26W/700mA/Max.37V
 CCT :2700/3000/4000K
 Flux :2600lm
 CRI :≥92
 Cutout :ø55mm

Beam angle :
 15°- 60°



ROBO - ZOOM

LED CEILING RECESSED

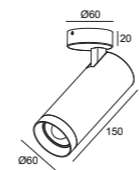

CH0177

Power :1X15W/AC230v-50Hz
 CCT :2700/3000/4000K
 Flux :1160lm
 CRI :≥92

Beam angle :
 15°- 60°



15°- 60°

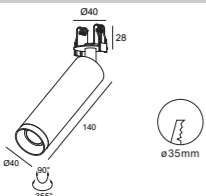

DL1388

Power :1X5W/500mA/Max.10V
 CCT :2700/3000/4000K
 Flux :430lm
 CRI :≥92
 Cutout :ø35mm

Beam angle :
 15°-36°

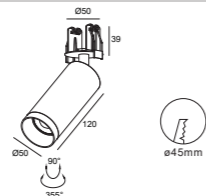

DL1180

Power :1X13W/350mA/Max.37V
 CCT :2700/3000/4000K
 Flux :1300lm
 CRI :≥92
 Cutout :ø50mm

Beam angle :
 15°-60°

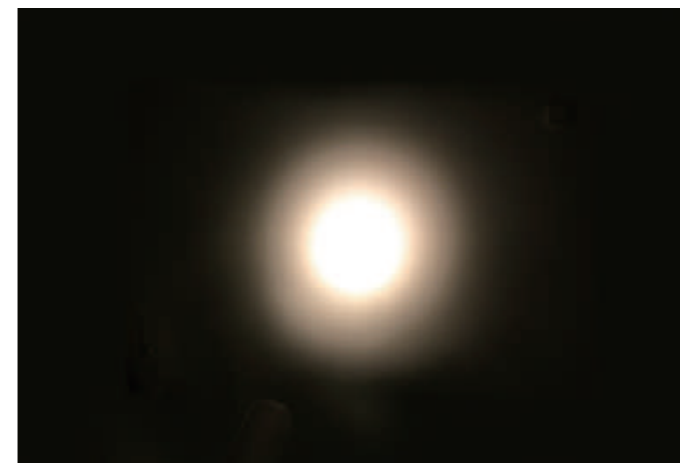

15°

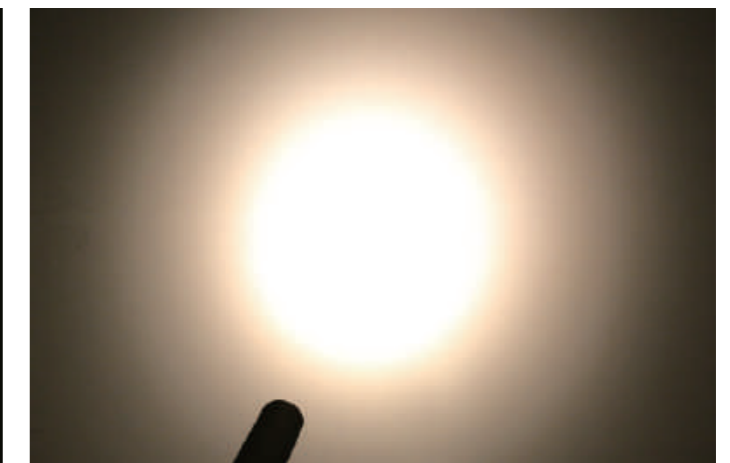

60°

ROBO - Wall Washer

COLOR: TW TB

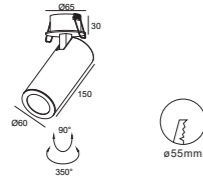

DL1001

Power : 1x13W/350mA/Max.37V
 CCT : 2700/3000/4000K
 Flux : 1160lm
 CRI : ≥92
 Cutout : ø55mm

Beam angle :
 36°x39°



ROBO - Wall Washer

LED CEILING RECESSED

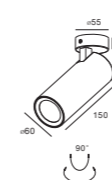

CH0156

Power : 1x13W/350mA/Max.37V
 CCT : 2700/3000/4000K
 Flux : 1160lm
 CRI : ≥92

Beam angle :
 36°x39°



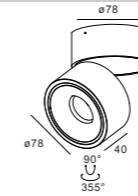
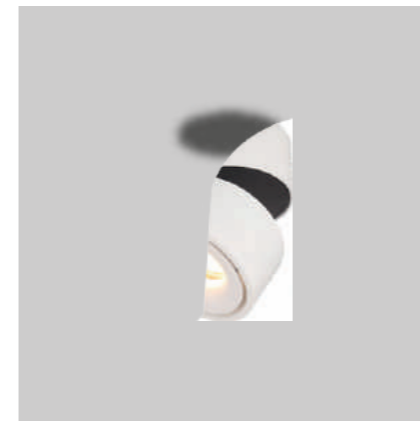

CH0075

Power :1X10W/AC230V-50Hz
 CCT :2700/3000/4000K
 Flux :780lm
 CRI :≥90
 Cutout :ø90mm

Beam angle :
 15° 24° 36°

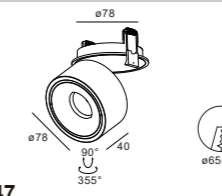

DL1047

Power :1X8W/180mA/Max.37V
 CCT :2700/3000/4000K
 Flux :780lm
 CRI :≥90
 Cutout :ø65mm

Beam angle :
 15° 24° 36°

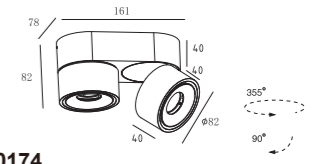

CH0174

Power :20W/AC230V-50Hz
 CCT :2700/3000/4000K
 Flux :2X780lm
 CRI :≥90

Beam angle :
 15° 24° 36°

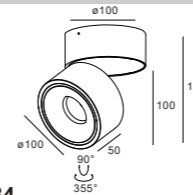
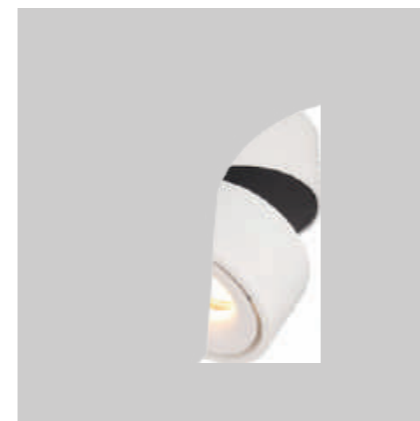

CH0034

Power :1X13W/AC230V-50Hz
 CCT :2700/3000/4000K
 Flux :1100lm
 CRI :≥92

Beam angle :
 15° 25° 38° 60°

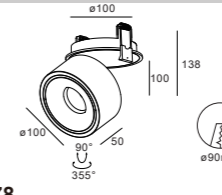

DL0278

Power :1X13W/350mA/Max.37V
 CCT :2700/3000/4000K
 Flux :1100lm
 CRI :≥90
 Cutout :ø90mm

Beam angle :
 15° 25° 38° 60°

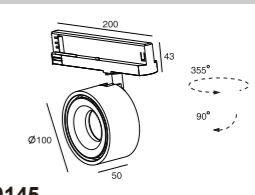

TR0145

Power :1X14W/AC230V-50Hz
 CCT :2700/3000/4000K
 Flux :1100lm
 CRI :≥90

Beam angle :
 15° 25° 38° 60°



ROBO - Wall Washer

COLOR: TW TB

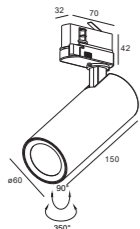

TR0099
 Power :1X15W/AC230V-50Hz
 CCT :2700/3000/4000K
 Flux :1300lm
 CRI :≥92
 Beam angle : 36°X39°

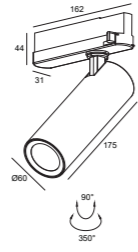

TR0120
 Power :1X20W/AC220V-50Hz
 CCT :2700/3000/4000K
 Flux :1800lm
 CRI :≥92
 Beam angle : 36°X39°

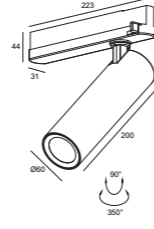

TR0121
 Power :1X30W/AC220V-50Hz
 CCT :2700/3000/4000K
 Flux :2600lm
 CRI :≥92
 Beam angle : 36°X39°

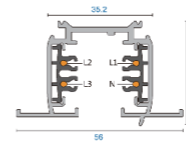
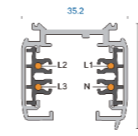

Four Wires Three Phase

LED TRACK LIGHT



ROLL

COLOR: TW TB

LED CEILING SURFACE

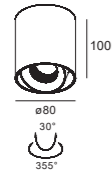
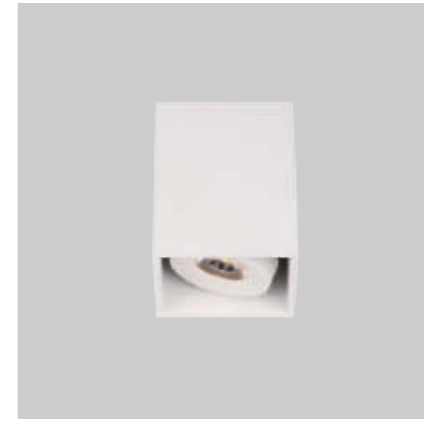
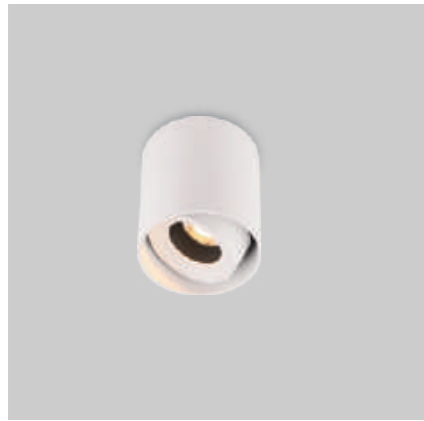

CH0155

Power :1X8W/AC230V-50Hz
 CCT :2700/3000/4000K
 Flux :630lm
 CRI :≥92

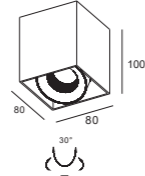
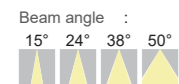

CH0151

Power :1X8W/AC230V-50Hz
 CCT :2700/3000/4000K
 Flux :630lm
 CRI :≥92

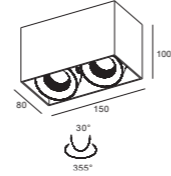
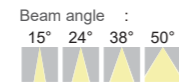

CH0164

Power :2X8W/AC230V-50Hz
 CCT :2700/3000/4000K
 Flux :2X630lm
 CRI :≥92

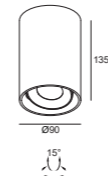
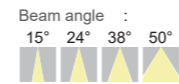

CH0175

Power :1X15W/AC230V-50Hz
 CCT :2700/3000/4000K
 Flux :1300lm
 CRI :≥92

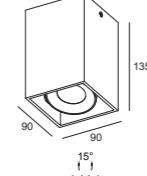
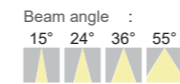

CH0176

Power :1X15W/AC230V-50Hz
 CCT :2700/3000/4000K
 Flux :1300lm
 CRI :≥92

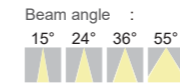

ROLL

COLOR: TW TB

LED CEILING SURFACE

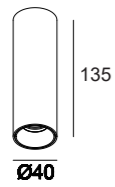

CH0185

Power :1X8W/AC230v-50Hz
 CCT :2700/3000/4000K
 Flux :1170lm
 CRI :≥92

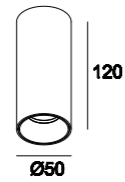
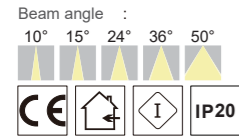

CH0186

Power :1X10W/AC230v-50Hz
 CCT :2700/3000/4000K
 Flux :960lm
 CRI :≥92

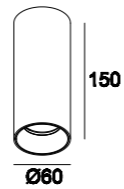
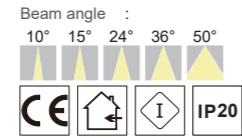

CH0187

Power :1X15W/AC230v-50Hz
 CCT :2700/3000/4000K
 Flux :1300lm
 CRI :≥92

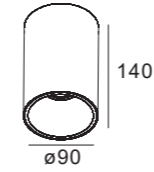
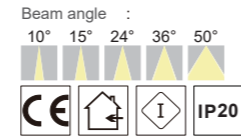

CH0076

Power :1X11W/AC230V-50Hz
 CCT :2700/3000/4000K
 Flux :900lm
 CRI :≥92

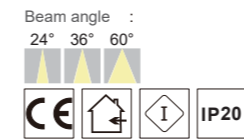

CH0077

Power :1X15W/AC230V-50Hz
 CCT :2700/3000/4000K
 Flux :1300lm
 CRI :≥92

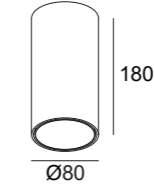
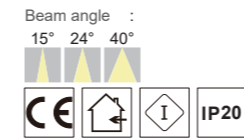

CH0205

Power :1X20W/AC230V-50Hz
 CCT :2700/3000/4000K
 Flux :1800lm
 CRI :≥92

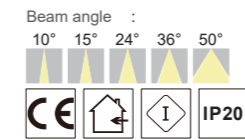

CH0206

Power :1X30W/AC230V-50Hz
 CCT :2700/3000/4000K
 Flux :2600lm
 CRI :≥92

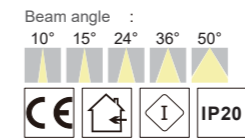

ROLL

COLOR: TW TB

LED CEILING SURFACE



DIFFERENT COMBINATION:

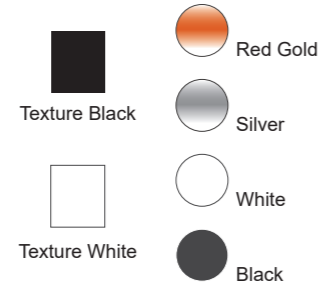

	Power	CCT	Flux	CRI	Optional
CH0066	1X15W/AC230-50Hz	2700/3000/4000K	1300lm	≥92	DALI, Triac
CH0067	1X20W/AC230-50Hz	2700/3000/4000K	1800lm	≥92	DALI, Triac
CH0068	1X30W/AC230-50Hz	2700/3000/4000K	2600lm	≥92	DALI, Triac

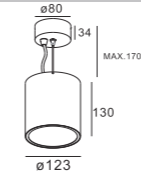
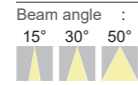
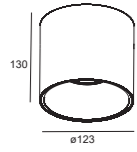

PH0023

Power :1X15/20/30W/AC230V-50Hz
 CCT :2700/3000/4000K
 Flux :2400lm
 CRI :≥92

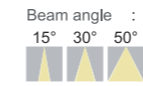

ROLL

COLOR: TW TB

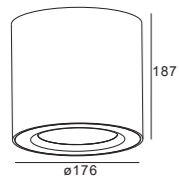

CH0081

Power	CCT	Flux	CRI	Optional
1X30W/AC230-50Hz	2700/3000/4000K	2600lm	≥92	Triac,DALI,0/1-10V

CH0082

1X38W/AC230-50Hz	2700/3000/4000K	3300lm	≥92	Triac,DALI,0/1-10V
------------------	-----------------	--------	-----	--------------------

CH0083

1X44W/AC230-50Hz	2700/3000/4000K	3900lm	≥92	Triac,DALI,0/1-10V
------------------	-----------------	--------	-----	--------------------

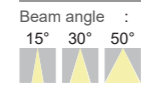

ZOOM

COLOR: TW TB

LEIBE DIE EINIGSAREIN.DAINT

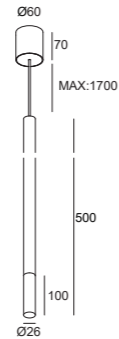
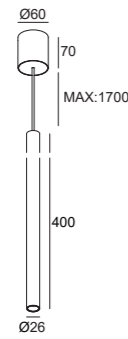

PH0024 L:400mm

Power :1X8W/AC230V-50Hz
 CCT :2700/3000/4000K
 Flux :730lm
 CRI :≥92

PH0044 L:500mm

Power :1X8W/AC230V-50Hz
 CCT :2700/3000/4000K
 Flux :730lm
 CRI :≥92

Beam angle :
 35° 50°

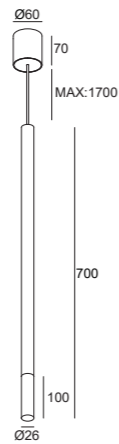
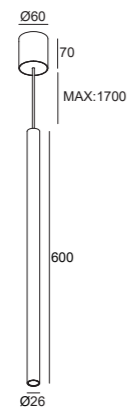

PH0025 L:600mm

Power :1X8W/AC230V-50Hz
 CCT :2700/3000/4000K
 Flux :730lm
 CRI :≥92

PH0046 L:700mm

Power :1X8W/AC230V-50Hz
 CCT :2700/3000/4000K
 Flux :730lm
 CRI :≥92

Beam angle :
 35° 50°

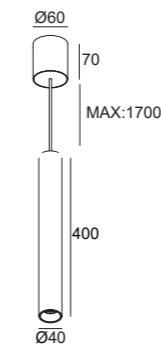
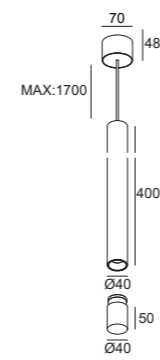

PH0011

Power :1X15W/AC230V-50Hz
 CCT :2700/3000/4000K
 Flux :1180lm
 CRI :≥92

PH0031

Power :1X15W/AC230v-50Hz
 CCT :2700/3000/4000K
 Flux :1300lm
 CRI :≥92

Beam angle :
 24° 36° 60°



Beam angle :
 15° 24° 36° 50°



ZOOM

COLOR: TW TB

LEBENSZEITENVERGLEICH

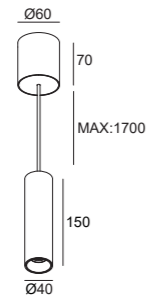

PH0028

Power :1X8W/AC230v-50Hz
 CCT :2700/3000/4000K
 Flux :730lm
 CRI :≥92

Beam angle :
 15° 24° 36° 50°

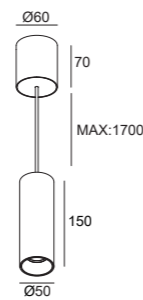

PH0029

Power :1X15W/AC230v-50Hz
 CCT :2700/3000/4000K
 Flux :1300lm
 CRI :≥92

Beam angle :
 15° 24° 36° 50°

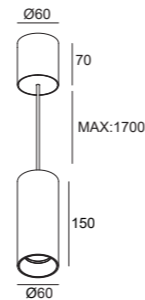

PH0030

Power :1X15W/AC230v-50Hz
 CCT :2700/3000/4000K
 Flux :1300lm
 CRI :≥92

Beam angle :
 15° 24° 36° 50°

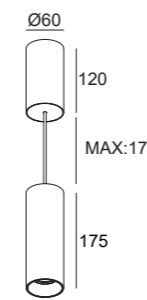

PH0040

Power :1X20W/AC230V-50Hz
 CCT :2700/3000/4000K
 Flux :1800lm
 CRI :≥92

Beam angle :
 15° 24° 36° 50°

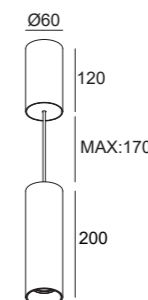

PH0041

Power :1X30W/AC230V-50Hz
 CCT :2700/3000/4000K
 Flux :2900lm
 CRI :≥92

Beam angle :
 15° 24° 36° 50°



ZOOM

COLOR: TW TB

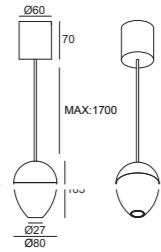

PH0047

Power :1X7W/AC230V-50Hz
 CCT :2700/3000/4000K
 Flux :630lm
 CRI :≥92

Beam angle :
 15° 24° 36° 50°

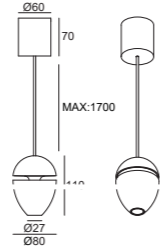

PH0035

Power :1X7W/AC230V-50Hz
 CCT :2700/3000/4000K
 Flux :630lm
 CRI :≥92

Beam angle :
 15° 24° 36° 50°

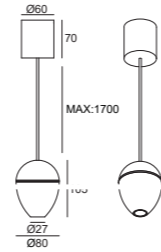

PH0036

Power :1X7W/AC230V-50Hz
 CCT :2700/3000/4000K
 Flux :630lm
 CRI :≥92

Beam angle :
 15° 24° 36° 50°

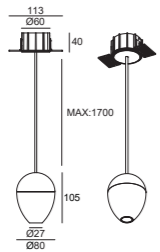

PH0048

Power :1X7W/AC230V-50Hz
 CCT :2700/3000/4000K
 Flux :630lm
 CRI :≥92
 Cutout :ø75mm

Beam angle :
 15° 24° 36° 50°

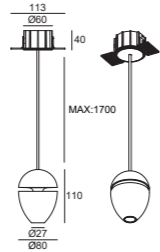

PH0038

Power :1X7W/AC230V-50Hz
 CCT :2700/3000/4000K
 Flux :630lm
 CRI :≥92
 Cutout :ø75mm

Beam angle :
 15° 24° 36° 50°

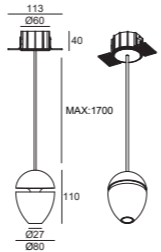

PH0039

Power :1X7W/AC230V-50Hz
 CCT :2700/3000/4000K
 Flux :630lm
 CRI :≥92
 Cutout :ø75mm

Beam angle :
 15° 24° 36° 50°



ZOOM

COLOR: TW TB

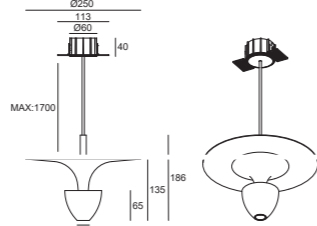
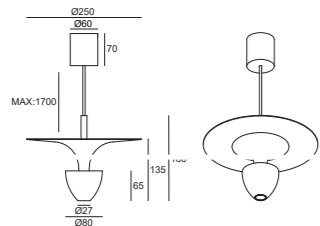

PH0032

Power :1X7W/AC230V-50Hz
 CCT :2700/3000/4000K
 Flux :630lm
 CRI :≥92

Beam angle :
 15 24 36 50



PH0037

Power :1X7W/AC230V-50Hz
 CCT :2700/3000/4000K
 Flux :630lm
 CRI :≥92
 Cutout :ø75mm

Beam angle :
 15 24 36 50



ZOOM

COLOR: TW TB

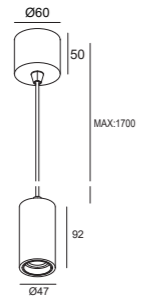

PH0040
E27
Cotout :N/A

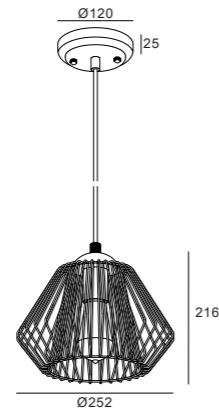

OL039
E27
Cotout :N/A

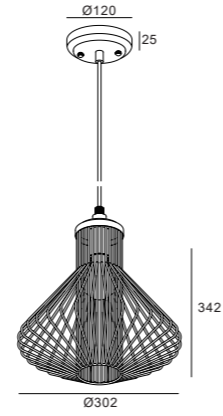

OL040
E27
Cotout :N/A



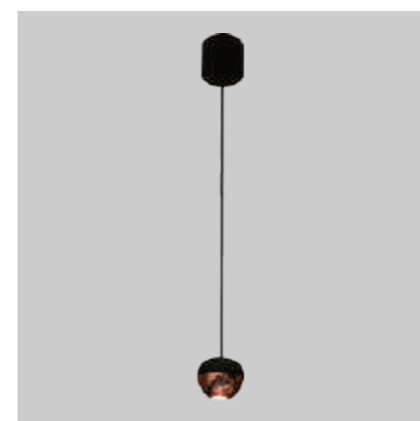

PH0018
 Power :1X4W/AC230V-50Hz
 CCT :2700/3000/4000K
 Flux :300lm
 CRI :≥92

Beam angle :
 35° 50°

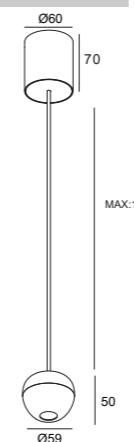

PH0042
 Power :1X7W/AC230V-50Hz
 CCT :2700/3000/4000K
 Flux :1800lm
 CRI :≥92

Beam angle :N/A

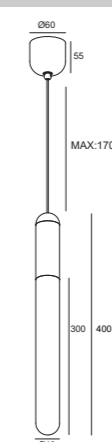

OVAL-Indoor

COLOR: TW TB AB BC CP RG AG GL

LED WALL LIGHT

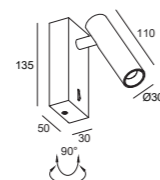
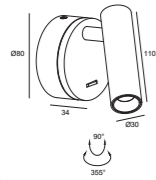
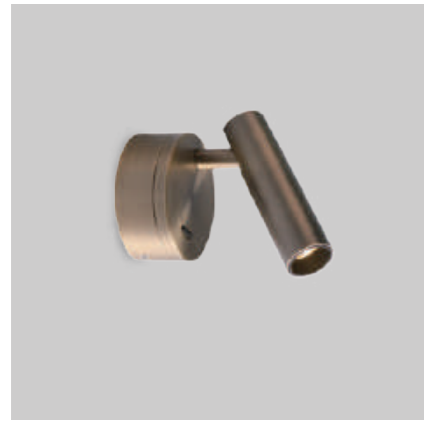

WL0020

Power :1X3W/AC230V-50Hz
 CCT :2700/3000/4000K
 Flux :160lm
 CRI :≥85

WL0053

Power :1X3W/AC230V-50Hz
 CCT :2700/3000/4000K
 Flux :160lm
 CRI :≥85

Beam angle :
 10° 20° 40° 60°



Beam angle :
 10° 20° 40° 60°

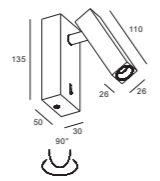
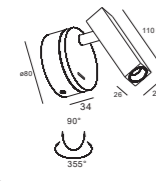

WL0029

Power :1X3W/AC230V-50Hz
 CCT :2700/3000/4000K
 Flux :160lm
 CRI :≥85

WL0048

Power :1X3W/AC230V-50Hz
 CCT :2700/3000/4000K
 Flux :160lm
 CRI :≥85

Beam angle :
 10° 20° 40° 60°



Beam angle :
 10° 20° 40° 60°



Led Reading Light



OVAL-Indoor

COLOR: TW TB

LED WALL LIGHT

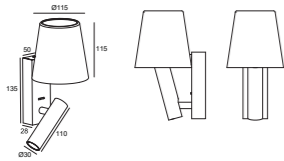

WL0060

Power :1X3W/AC220V-50Hz
 CCT :2700/3000/4000K
 Flux :180lm
 CRI :≥85

Beam angle

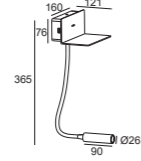
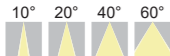

WL0041

Power :1X3W/AC230V-50Hz
 CCT :2700/3000/4000K
 Flux :160lm
 CRI :≥85

Beam angle :

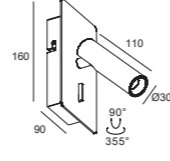

WL0042

Power :1X3W/AC230V-50Hz
 CCT :2700/3000/4000K
 Flux :180lm
 CRI :≥85

Beam angle :

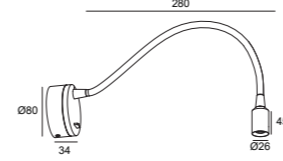
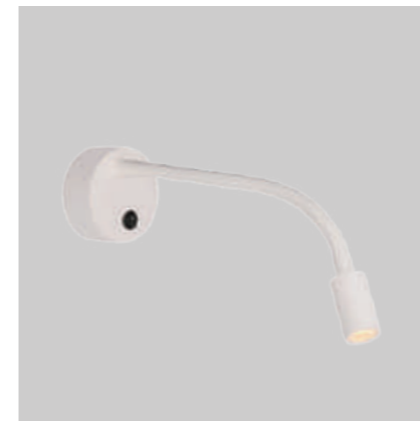
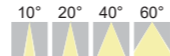

WL0087

Power :1X3W/AC230V-50Hz
 CCT :2700/3000/4000K
 Flux :160lm
 CRI :≥85

Beam angle :

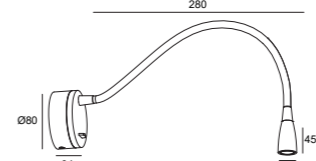
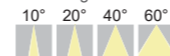

WL0088

Power :1X3W/AC230V-50Hz
 CCT :2700/3000/4000K
 Flux :160lm
 CRI :≥85

Beam angle :

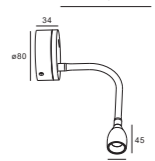
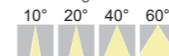

WL0046

Power :1X3W/AC230V-50Hz
 CCT :2700/3000/4000K
 Flux :160lm
 CRI :≥85

Beam angle :

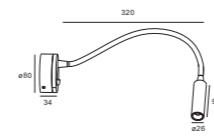
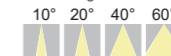

WL0049

Power :1X3W/AC230V-50Hz
 CCT :2700/3000/4000K
 Flux :160lm
 CRI :≥85

Beam angle :

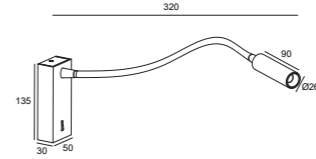

WL0038

Power :1X3W/AC230V-50Hz
 CCT :2700/3000/4000K
 Flux :160lm
 CRI :≥85

Beam angle :



OVAL-Indoor

COLOR: TW TB

LED WALL LIGHT

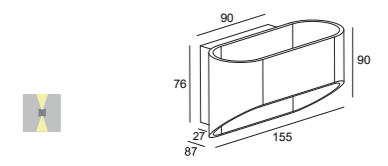
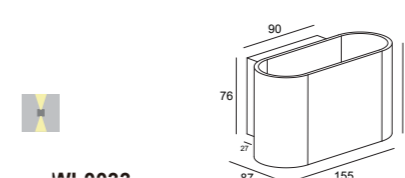
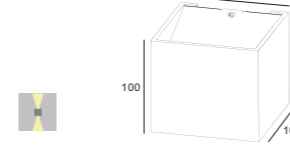
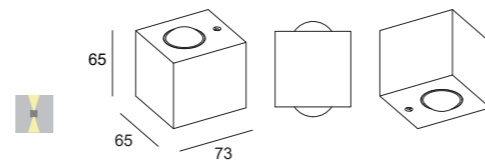
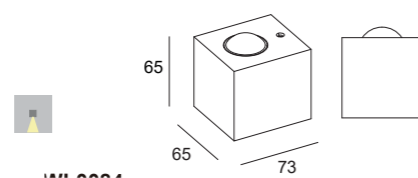
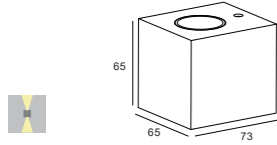
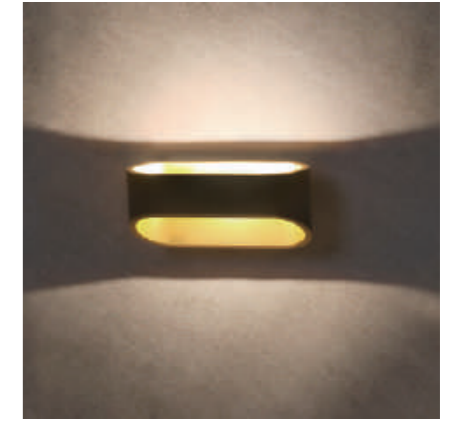
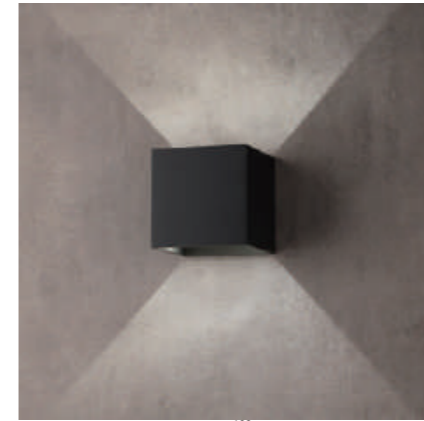
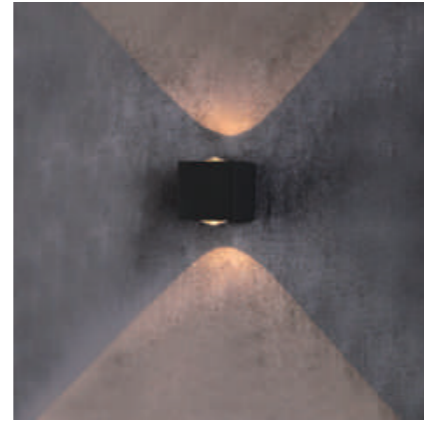
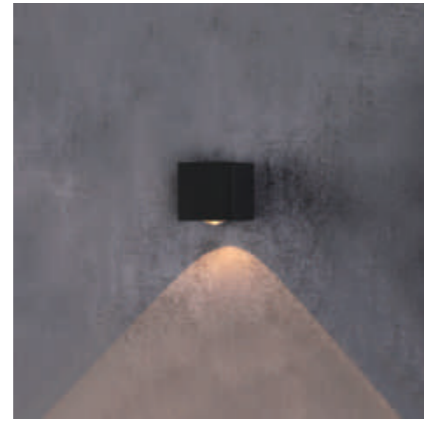

WL0015
 Power :1X3W/AC230V-50Hz
 CCT :2700/3000/4000K
 Flux :130lm
 CRI :≥85

WL0004
 Power :1X2W/AC230V-50Hz
 CCT :2700/3000/4000K
 Flux :420lm
 CRI :≥92

WL0005
 Power :1X3W/AC230V-50Hz
 CCT :2700/3000/4000K
 Flux :420lm
 CRI :≥92

WL0024
 Power :1X8W/AC230V-50Hz
 CCT :2700/3000/4000K
 Flux :420lm
 CRI :≥92

WL0000
 Power :1X8W/AC230V-50Hz
 CCT :2700/3000/4000K
 Flux :620lm
 CRI :≥92

WL0022
 Power :1X8W/AC230V-50Hz
 CCT :2700/3000/4000K
 Flux :400lm
 CRI :≥92



GRILL

COLOR: TW TB

LED CEILING RECESSED

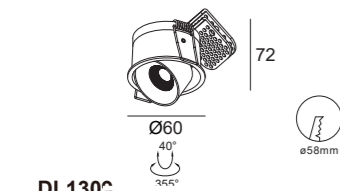
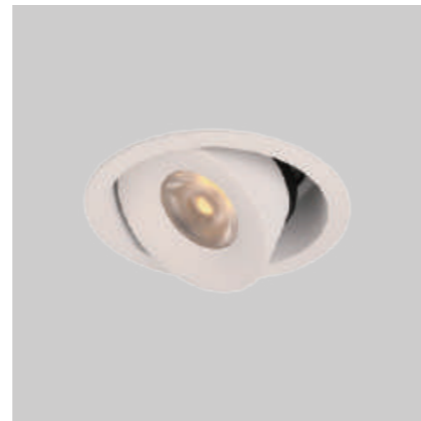
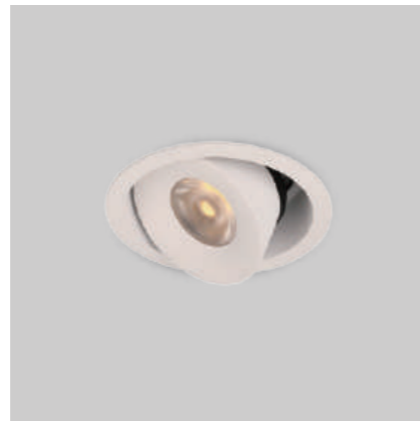
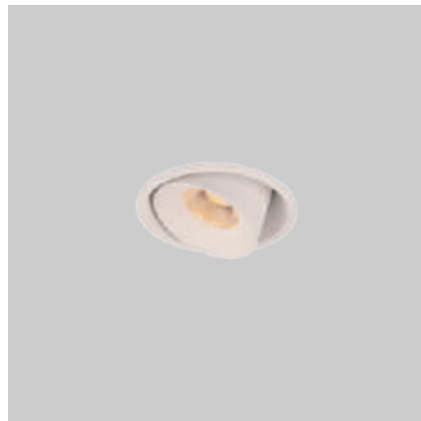

DL130C

Power :1X7W/350mA/Max.19V
 CCT :2700/3000/4000K
 Flux :630lm
 CRI :≥92
 Cutout :ø58mm

Beam angle :
 15° 24° 36° 55°

CE, Home, III, 1-25mm, IP20

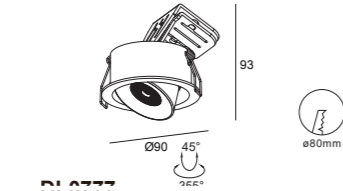

DL0777

Power :1X12W/350mA/Max.37V
 CCT :2700/3000/4000K
 Flux :1200lm
 CRI :≥92
 Cutout :ø80mm

Beam angle :
 15° 24° 36° 60°

CE, Home, III, 1-30mm, IP20

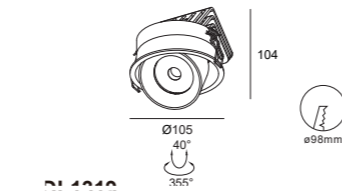

DL1010

Power :1X26W/700mA/Max.37V
 CCT :2700/3000/4000K
 Flux :2600lm
 CRI :≥92
 Cutout :ø98mm

Beam angle :
 15° 24° 36° 60°

CE, Home, III, 1-35mm, IP20

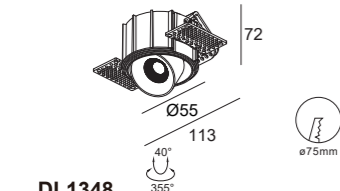
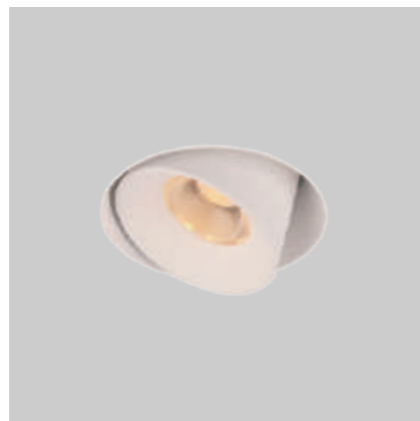
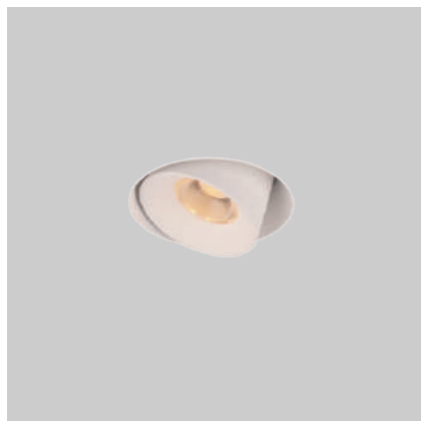

DL1348

Power :1X7W/350mA/Max.19V
 CCT :2700/3000/4000K
 Flux :630lm
 CRI :≥92
 Cutout :ø75mm

Beam angle :
 15° 24° 36° 55°

CE, Home, III, 2-38mm, IP20

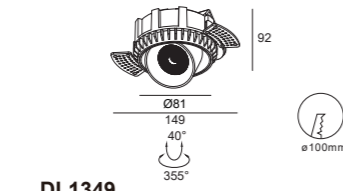

DL1349

Power :1X13W/350mA/Max.37V
 CCT :2700/3000/4000K
 Flux :1200lm
 CRI :≥92
 Cutout :ø100mm

Beam angle :
 15° 24° 36° 55°

CE, Home, III, 1-25mm, IP20

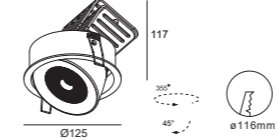

DL0038

Power	CCT	Flux	CRI	Cutout
1X13W/350mA/Max.37V	2700/3000/4000K	1300lm	≥92	Ø116mm

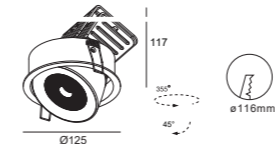

DL0039

1X18W/500mA/Max.37V	2700/3000/4000K	1800lm	≥92	Ø116mm
---------------------	-----------------	--------	-----	--------

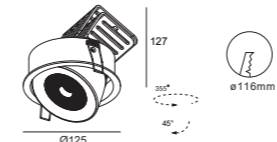

DL0040

1X26W/700mA/Max.37V	2700/3000/4000K	2600lm	≥92	Ø116mm
---------------------	-----------------	--------	-----	--------

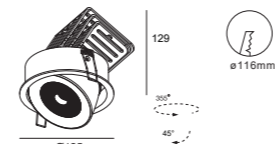

DL0041

1X33W/900mA/Max.37V	2700/3000/4000K	3300lm	≥92	Ø116mm
---------------------	-----------------	--------	-----	--------

Beam angle :
 15° 24° 36°

CE, Home, III, 1-30mm, IP20

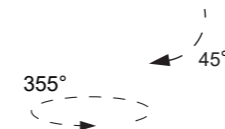

GRILL

COLOR: TW TB

LED CEILING RECESSED

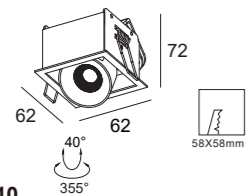
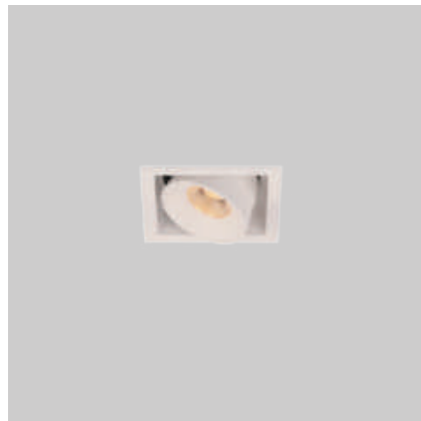

DL1310
 Power :1X7W/350mA/Max.19V
 CCT :2700/3000/4000K
 Flux :760lm
 CRI :≥92
 Cutout :58X58mm

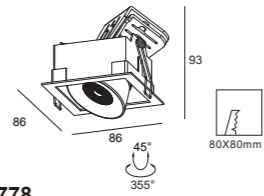
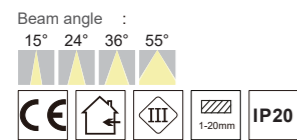

DL0778
 Power :1X12W/350mA/Max.37V
 CCT :2700/3000/4000K
 Flux :1200lm
 CRI :≥92
 Cutout :80X80mm

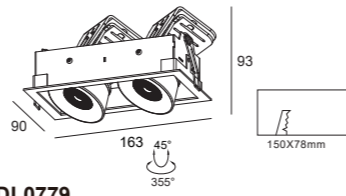
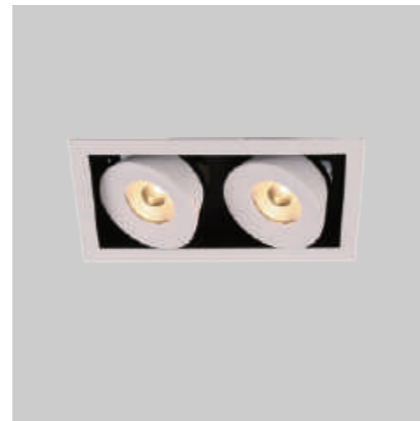
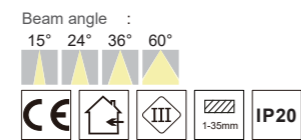

DL0779
 Power :2X12W/350mA/2XMax.37V
 CCT :2700/3000/4000K
 Flux :2X1200lm
 CRI :≥92
 Cutout :150X78mm

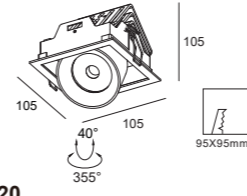
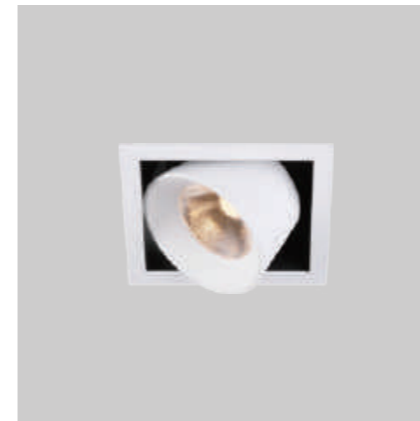
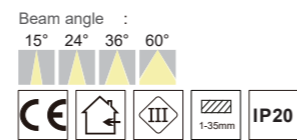

DL1320
 Power :1X26W/700mA/Max.37V
 CCT :2700/3000/4000K
 Flux :2600lm
 CRI :≥92
 Cutout :95X95mm

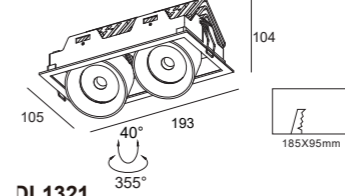
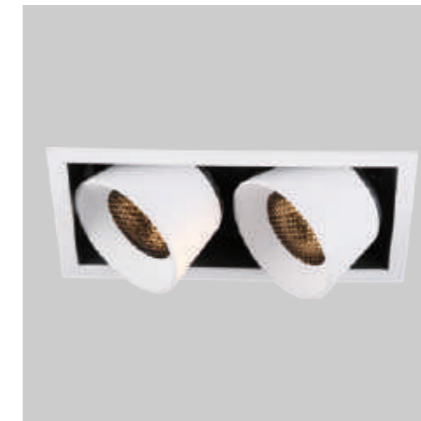
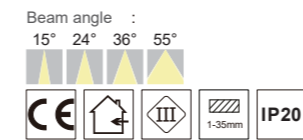

DL1321
 Power :2X26W/700mA/2XMax.37V
 CCT :2700/3000/4000K
 Flux :2X2600lm
 CRI :≥92
 Cutout :185X95mm

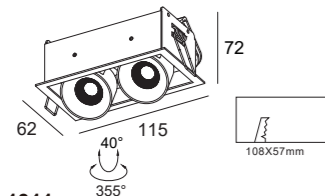
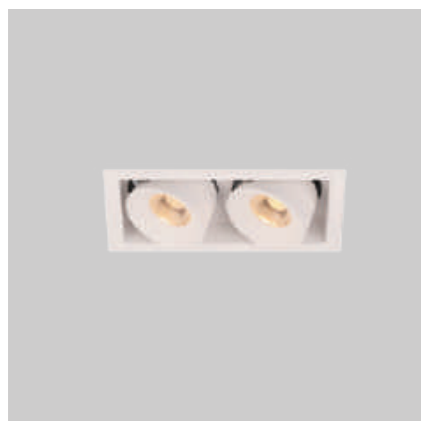
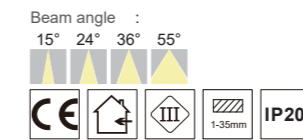

DL1311
 Power :2X7W/350mA/2xMax.19V
 CCT :2700/3000/4000K
 Flux :2X760lm
 CRI :≥92
 Cutout :108X57mm

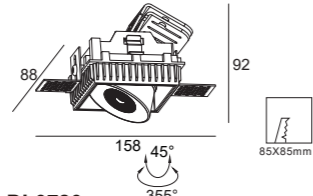
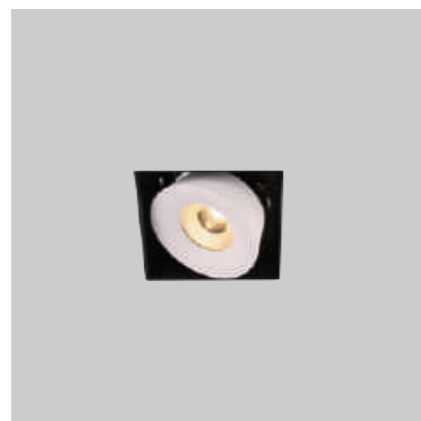
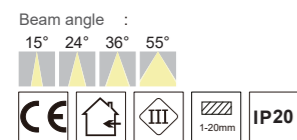

DL0780
 Power :1X12W/350mA/Max.37V
 CCT :2700/3000/4000K
 Flux :1200lm
 CRI :≥92
 Cutout :85X85mm

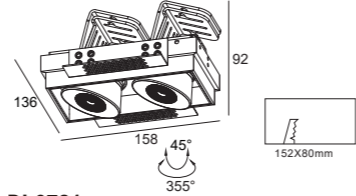
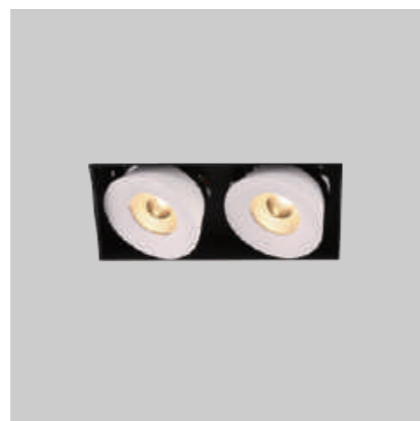
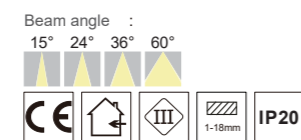

DL0781
 Power :2X12W/350mA/2XMax.37V
 CCT :2700/3000/4000K
 Flux :2X1200lm
 CRI :≥92
 Cutout :152X80mm

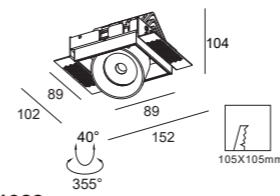
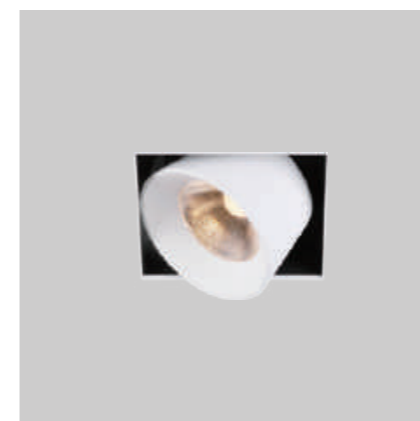
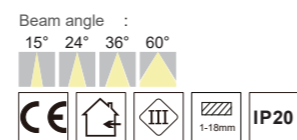

DL1322
 Power :1X26W/700mA/Max.37V
 CCT :2700/3000/4000K
 Flux :2600lm
 CRI :≥92
 Cutout :105X105mm

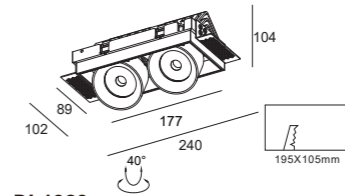
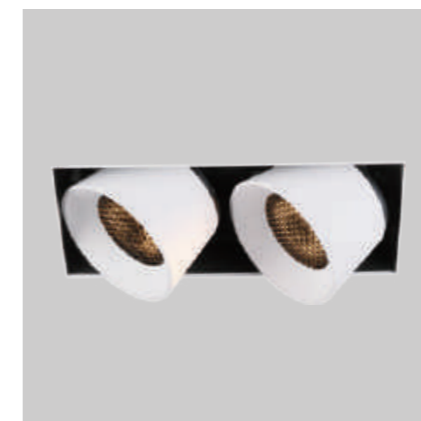
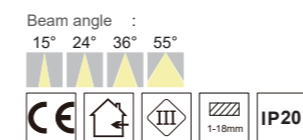

DL1323
 Power :2X26W/700mA/2XMax.37V
 CCT :2700/3000/4000K
 Flux :2X2600lm
 CRI :≥92
 Cutout :195X105mm

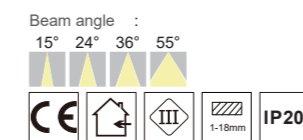

GRILL

COLOR: TW TB

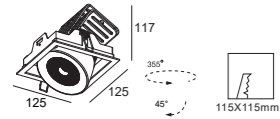

DL0042

Power	CCT	Flux	CRI	Cutout
1X13W/350mA/Max.37V	2700/3000/4000K	1300lm	≥92	115X115mm

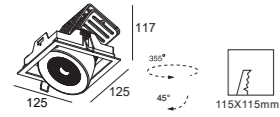

DL0043

1X18W/500mA/Max.37V	2700/3000/4000K	1800lm	≥92	115X115mm
---------------------	-----------------	--------	-----	-----------

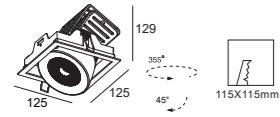

DL0044

1X26W/700mA/Max.37V	2700/3000/4000K	2600lm	≥92	115X115mm
---------------------	-----------------	--------	-----	-----------

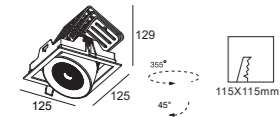

DL0045

1X33W/900mA/Max.37V	2700/3000/4000K	3300lm	≥92	115X115mm
---------------------	-----------------	--------	-----	-----------

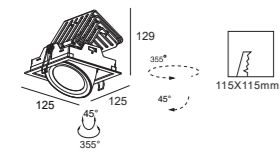

DL1182

1X39W/1050mA/Max.37V	2700/3000/4000K	3900lm	≥92	115X115mm
----------------------	-----------------	--------	-----	-----------

Beam angle :
15° 24° 36°



LED CEILING RECESSED

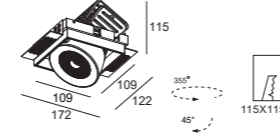
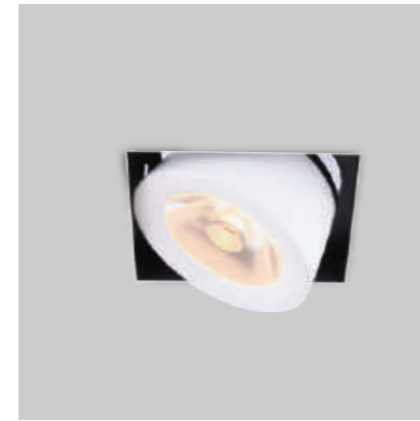

DL0046

Power	CCT	Flux	CRI	Cutout
1X13W/350mA/Max.37V	2700/3000/4000K	1300lm	≥92	115X115mm

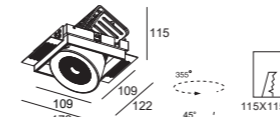

DL0047

1X18W/500mA/Max.37V	2700/3000/4000K	1800lm	≥92	115X115mm
---------------------	-----------------	--------	-----	-----------

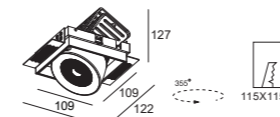

DL0048

1X26W/700mA/Max.37V	2700/3000/4000K	2600lm	≥92	115X115mm
---------------------	-----------------	--------	-----	-----------

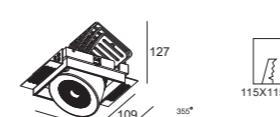

DL0049

1X33W/900mA/Max.37V	2700/3000/4000K	3300lm	≥92	115X115mm
---------------------	-----------------	--------	-----	-----------

Beam angle :
15° 24° 36°



GRILL

COLOR: TW TB

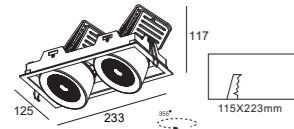

DL0050

Power	CCT	Flux	CRI	Cutout
2X13W/350mA/2X Max.37V	2700/3000/4000K	2X1300lm	≥92	115X223mm

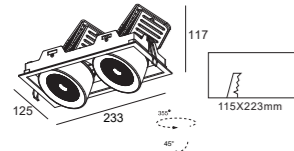

DL0051

2X18W/500mA/2X Max.37V	2700/3000/4000K	2X1800lm	≥92	115X223mm
------------------------	-----------------	----------	-----	-----------

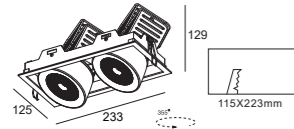

DL0052

2X26W/700mA/2X Max.37V	2700/3000/4000K	2X2600lm	≥92	115X223mm
------------------------	-----------------	----------	-----	-----------

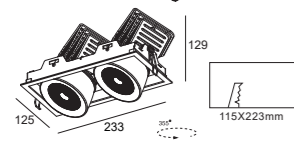

DL0053

2X33W/900mA/2X Max.37V	2700/3000/4000K	2X3300lm	≥92	115X223mm
------------------------	-----------------	----------	-----	-----------

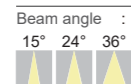

LED CEILING RECESSED

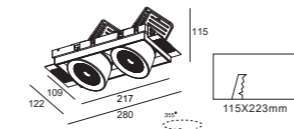
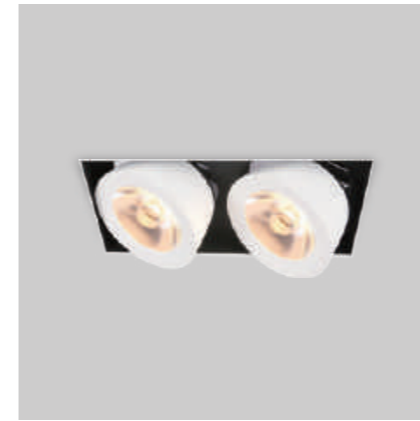

DL0054

Power	CCT	Flux	CRI	Cutout
2X13W/350mA/2X Max.37V	2700/3000/4000K	2X1300lm	≥92	115X223mm

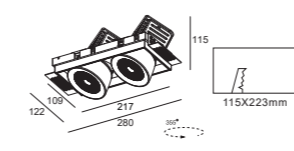

DL0055

2X18W/500mA/2X Max.37V	2700/3000/4000K	2X1800lm	≥92	115X223mm
------------------------	-----------------	----------	-----	-----------

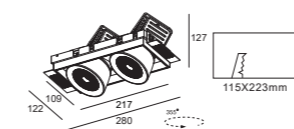

DL0056

2X26W/700mA/2X Max.37V	2700/3000/4000K	2X2600lm	≥92	115X223mm
------------------------	-----------------	----------	-----	-----------

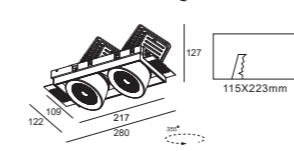

DL0057

2X33W/900mA/2X Max.37V	2700/3000/4000K	2X3300lm	≥92	115X223mm
------------------------	-----------------	----------	-----	-----------

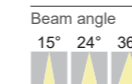

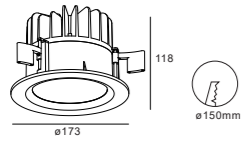

DL0218

Power	CCT	Flux	CRI	Cutout	Optional
13W/350mA/Max.37V	2700/3000/4000K	1300lm	≥92	ø150-230mm	DALI,PWM,or 1-10V Dimming

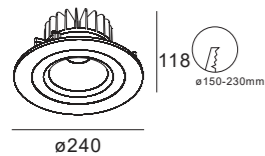

DL0346

18W/500mA/Max.37V	2700/3000/4000K	1800lm	≥92	ø150-230mm	DALI,PWM,or 1-10V Dimming
-------------------	-----------------	--------	-----	------------	---------------------------

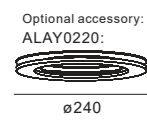

DL0219

26W/700mA/Max.37V	2700/3000/4000K	2600lm	≥92	ø150-230mm	DALI,PWM,or 1-10V Dimming
-------------------	-----------------	--------	-----	------------	---------------------------

DL0265

33W/900mA/Max.37V	2700/3000/4000K	3300lm	≥92	ø150-230mm	DALI,PWM,or 1-10V Dimming
-------------------	-----------------	--------	-----	------------	---------------------------

DL0266

39W/1050mA/Max.37V	2700/3000/4000K	3800lm	≥92	ø150-230mm	DALI,PWM,or 1-10V Dimming
--------------------	-----------------	--------	-----	------------	---------------------------

Beam angle :
15° 30° 50°

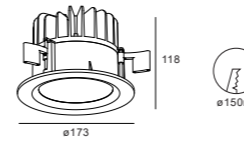

DL0482

Power	CCT	Flux	CRI	Cutout	Optional
10W/300mA/Max.37V	2700-6500K	1300lm	≥92	ø 150-230mm	DALI,or 1-10V Dimming

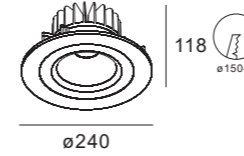

DL0483

18W/500mA/Max.37V	2700-6500K	1800lm	≥92	ø 150-230mm	DALI,PWM,or 1-10V Dimming
-------------------	------------	--------	-----	-------------	---------------------------

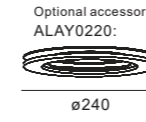

DL0484

26W/700mA/Max.37V	2700-6500K	2600lm	≥92	ø150-230mm	DALI,PWM,or 1-10V Dimming
-------------------	------------	--------	-----	------------	---------------------------

Beam angle :
15° 30° 50°



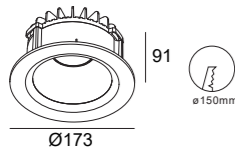

DL1405

Power	CCT	Flux	CRI	Cutout	Optional
15W/700mA/Max.19V	3000/3500/4000K	1300lm	≥92	ø150mm	DALI,or 1-10V Dimming

DL1406

20W/700mA/Max.28V	3000/3500/4000K	1800lm	≥92	ø150mm	DALI,or 1-10V Dimming
-------------------	-----------------	--------	-----	--------	-----------------------

DL1407

25W/700mA/Max.37V	3000/3500/4000K	2500lm	≥92	ø150mm	DALI,or 1-10V Dimming
-------------------	-----------------	--------	-----	--------	-----------------------

DL1408

30W/700mA/Max.45V	3000/3500/4000K	3200lm	≥92	ø150mm	DALI,or 1-10V Dimming
-------------------	-----------------	--------	-----	--------	-----------------------

Beam angle :
70°



ECO

COLOR: TW TB

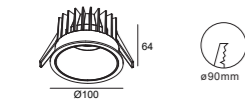

DL1429

Power	CCT	Flux	CRI	Cotout
1X18W/500mA/Max37V	2700/3000/4000K	1800lm	≥92/85	ø90mm

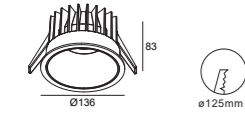

DL1431

1X26W/700mA/Max37V	2700/3000/4000K	2600lm	≥92/85	ø125mm
--------------------	-----------------	--------	--------	--------

Beam angle :
15° 24° 38° 55°

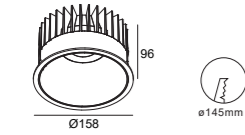
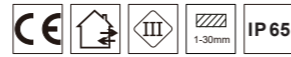

DL1433

1X33W/900mA/Max37V	2700/3000/4000K	3800lm	≥92/85	ø145mm
--------------------	-----------------	--------	--------	--------

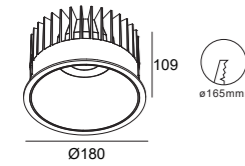

DL1435

1X43W/1200mA/Max37V	2700/3000/4000K	4300lm	≥92/85	ø165mm
---------------------	-----------------	--------	--------	--------

Beam angle :
15° 24° 38° 55°

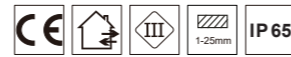

LED CEILING RECESSED

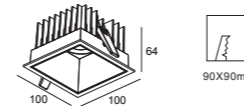
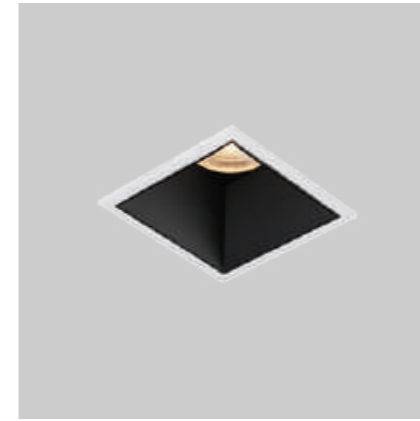

DL1430

Power	CCT	Flux	CRI	Cotout
1X18W/500mA/Max37V	2700/3000/4000K	1800lm	≥92/85	90X90mm

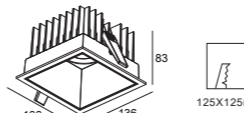

DL1432

1X26W/700mA/Max37V	2700/3000/4000K	2600lm	≥92/85	125X125mm
--------------------	-----------------	--------	--------	-----------

Beam angle :
15° 24° 38° 55°

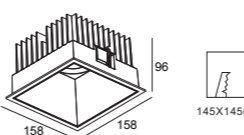

DL1434

1X33W/900mA/Max37V	2700/3000/4000K	3800lm	≥92/85	145X145mm
--------------------	-----------------	--------	--------	-----------

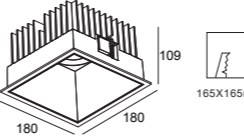

DL1436

1X43W/1200mA/Max37V	2700/3000/4000K	4300lm	≥92/85	165X165mm
---------------------	-----------------	--------	--------	-----------

Beam angle :
15° 24° 38° 55°



STAR

COLOR: TW TB BV

LED STEP LIGHT

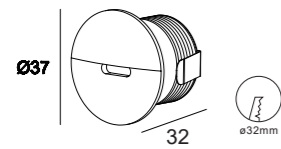
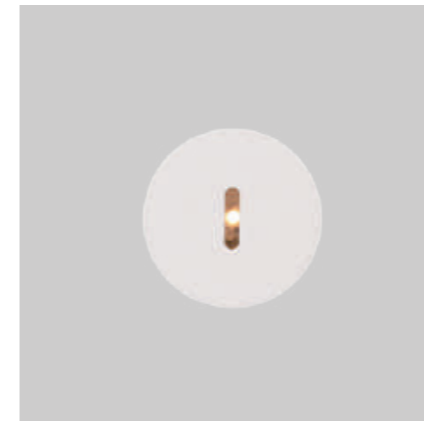
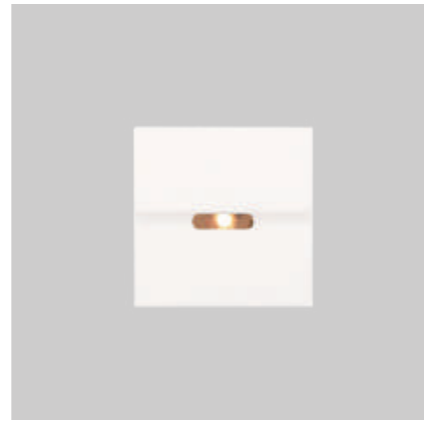
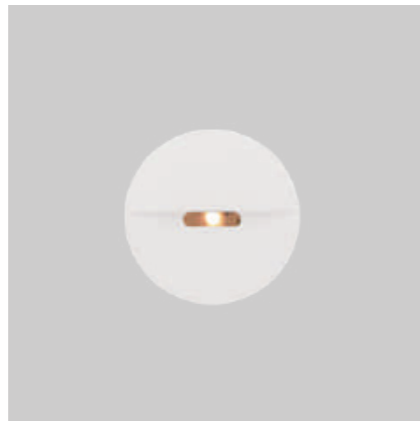

DL1170

Power :1W/350mA 2W/700mA/Max.3V
1W/DC24V
CCT :2700/3000/4000K
Flux :50lm/110lm
CRI :≥92
Cutout :ø32mm

Beam angle :N/A

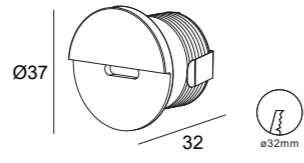

DL1221

Power :1W/350mA 2W/700mA/Max.3V
1W/DC24V
CCT :2700/3000/4000K
Flux :50lm/110lm
CRI :≥92
Cutout :ø32mm

Beam angle :N/A

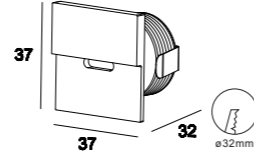

DL1220

Power :1W/350mA 2W/700mA/Max.3V
1W/DC24V
CCT :2700/3000/4000K
Flux :50lm/110lm
CRI :≥92
Cutout :ø32mm

Beam angle :N/A

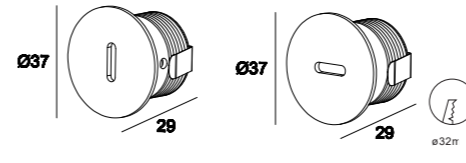

DL1172

Power :1W/350mA 2W/700mA/Max.3V
1W/DC24V
CCT :2700/3000/4000K
Flux :50lm/110lm
CRI :≥92
Cutout :ø32mm

Beam angle :N/A

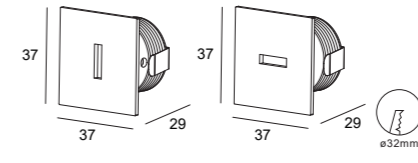

DL1213

Power :1W/350mA 2W/700mA/Max.3V
1W/DC24V
CCT :2700/3000/4000K
Flux :50lm/110lm
CRI :≥92
Cutout :ø32mm

Beam angle :N/A

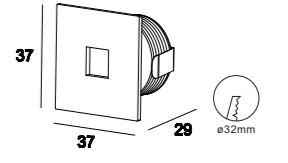

DL1214

Power :1W/350mA 2W/700mA/Max.3V
1W/DC24V
CCT :2700/3000/4000K
Flux :50lm/110lm
CRI :≥92
Cutout :ø32mm

Beam angle :N/A



STAR

COLOR: TW TB BV

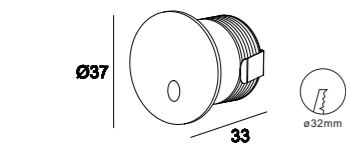
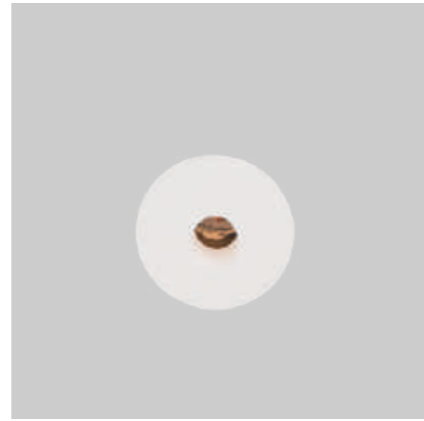
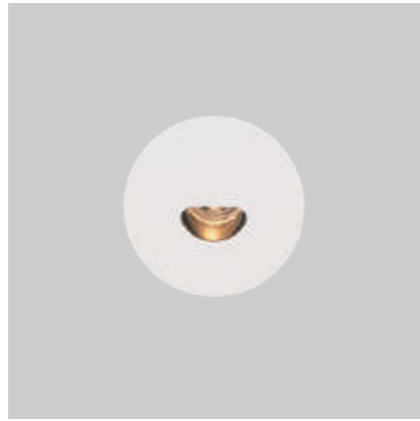
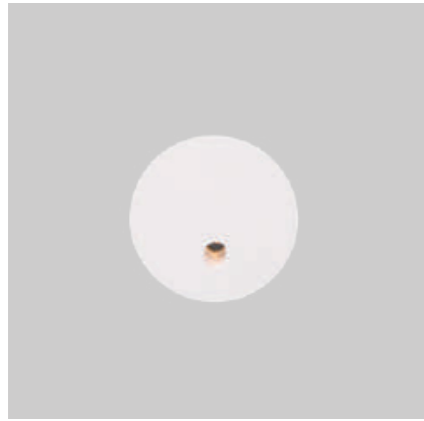

DL1219
 Power :1W/350mA 2W/700mA/Max.3V
 1W/DC24V
 CCT :2700/3000/4000K
 Flux :50lm/110lm
 CRI :≥92
 Cutout :ø32mm

Beam angle :N/A

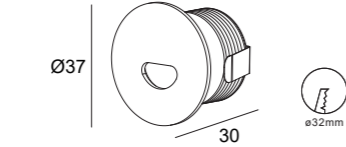
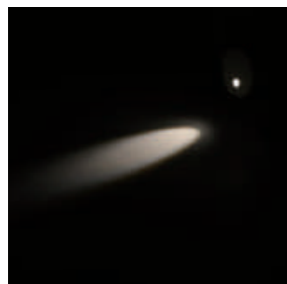

DL1218
 Power :1W/350mA 2W/700mA/Max.3V
 1W/DC24V
 CCT :2700/3000/4000K
 Flux :50lm/110lm
 CRI :≥92
 Cutout :ø32mm

Beam angle :N/A

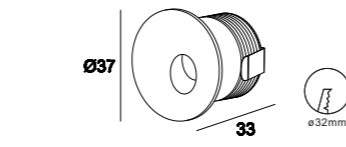

DL1216
 Power :1W/350mA 2W/700mA/Max.3V
 1W/DC24V
 CCT :2700/3000/4000K
 Flux :50lm/110lm
 CRI :≥92
 Cutout :ø32mm

Beam angle :N/A

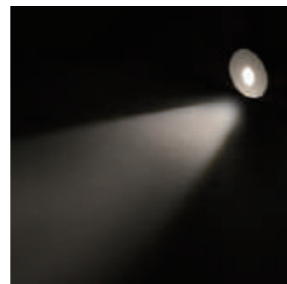

LED STEP LIGHT

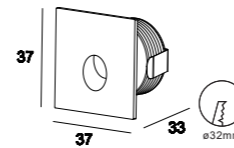
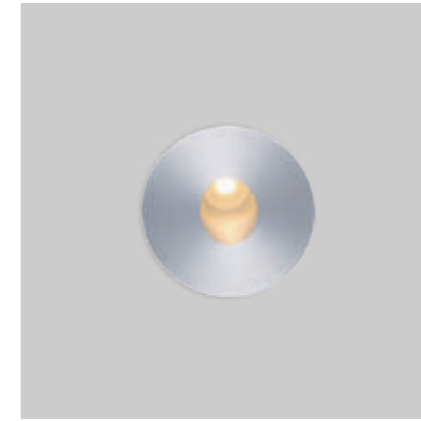
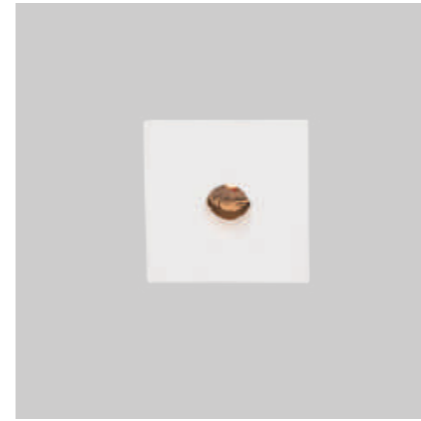

DL1215
 Power :1W/350mA 2W/700mA/Max.3V
 1W/DC24V
 CCT :2700/3000/4000K
 Flux :50lm/110lm
 CRI :≥92
 Cutout :ø32mm

Beam angle :N/A

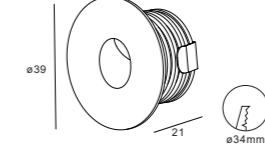
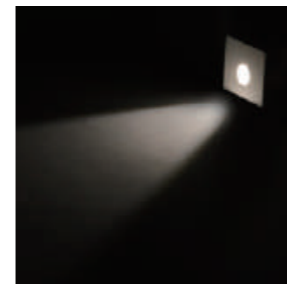

DL0316
 Power :1W/350mA 2W/700mA/Max.3V
 CCT :2700/3000/4000K
 Flux :50lm/110lm
 CRI :≥85
 Cutout :ø34mm

Beam angle :N/A

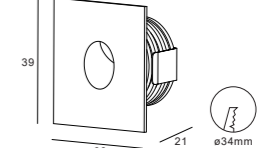
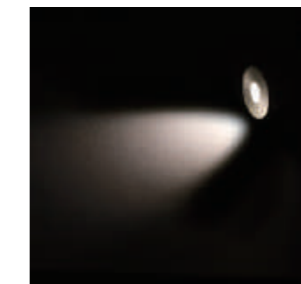

DL0290
 Power :1W/350mA 2W/700mA/Max.3V
 CCT :2700/3000/4000K
 Flux :50lm/110lm
 CRI :≥85
 Cutout :ø34mm

Beam angle :N/A

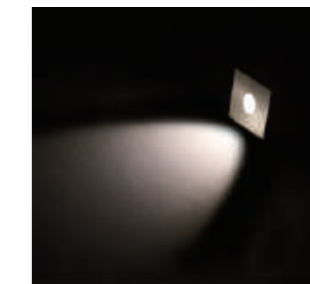

STAR

COLOR: TW TB BV

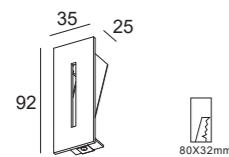
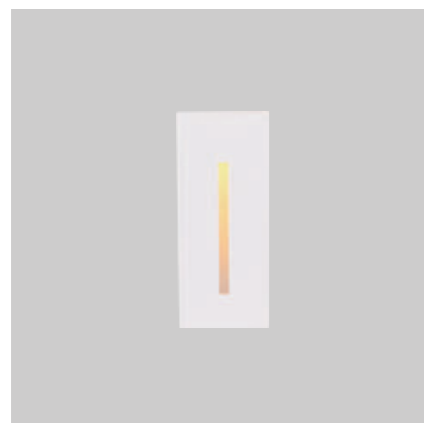

DL0891

Power :2W/700mA/Max.3V
CCT :2700/3000/4000K
Flux :40lm/100lm
CRI :≥85
Cutout :80X32mm

Beam angle :N/A

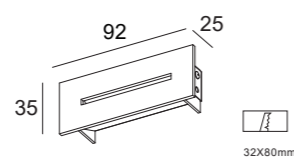
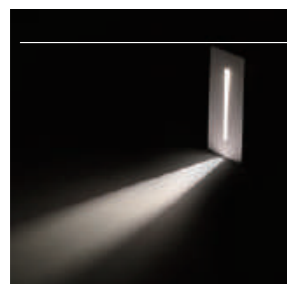

DL1146

Power :2W/700mA/Max.3V
CCT :2700/3000/4000K
Flux :40lm/100lm
CRI :≥92/85
Cutout :32X80mm

Beam angle :N/A

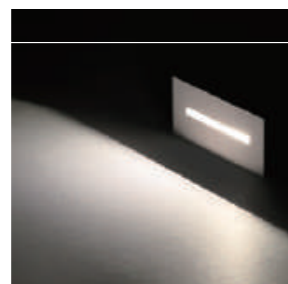

STAR

COLOR: TW TB BV GL AA

LED STEP LIGHT

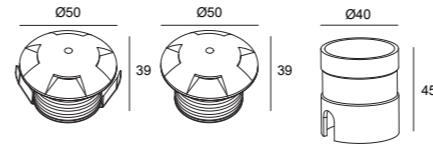
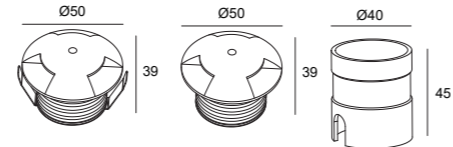
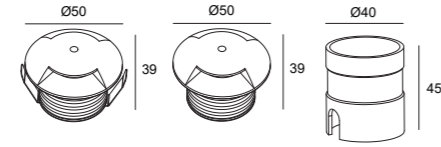
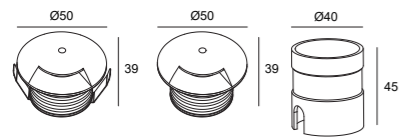
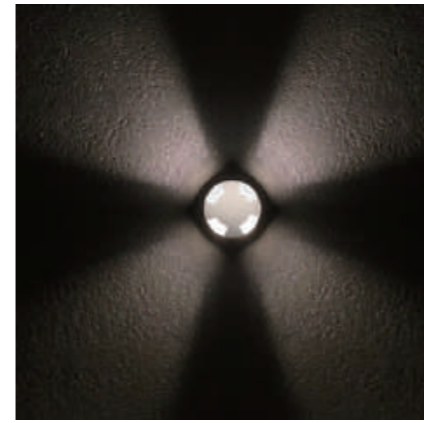
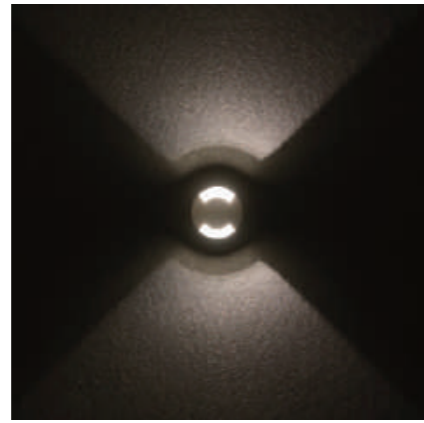

DL1195
 Power :2W/700mA/Max.3V
 CCT :2700/3000/4000K
 Flux :100lm
 CRI :≥92
 Cutout :ø36mm

DL1196
 Power :2W/700mA/Max.3V
 CCT :2700/3000/4000K
 Flux :100lm
 CRI :≥92
 Cutout :ø36mm

DL1197
 Power :2W/700mA/Max.3V
 CCT :2700/3000/4000K
 Flux :100lm
 CRI :≥92
 Cutout :ø36mm

DL1198
 Power :2W/700mA/Max.3V
 CCT :2700/3000/4000K
 Flux :100lm
 CRI :≥92
 Cutout :ø36mm

Beam angle :N/A

Beam angle :N/A

Beam angle :N/A

Beam angle :N/A

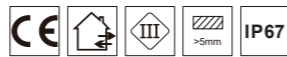

STAR

COLOR: TW TB BV GL AA

LED STEP LIGHT

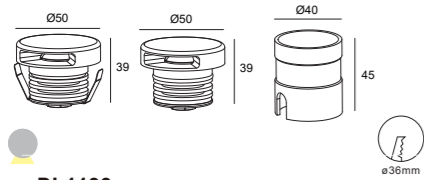

DL1199
 Power :2W/700mA/Max.3V
 CCT :2700/3000/4000K
 Flux :100lm
 CRI :≥92
 Cutout :ø36mm

Beam angle :N/A

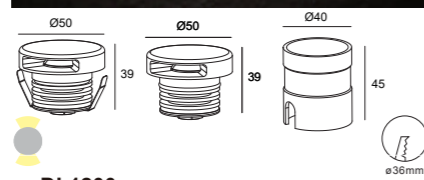

DL1200
 Power :2W/700mA/Max.3V
 CCT :2700/3000/4000K
 Flux :100lm
 CRI :≥92
 Cutout :ø36mm

Beam angle :N/A

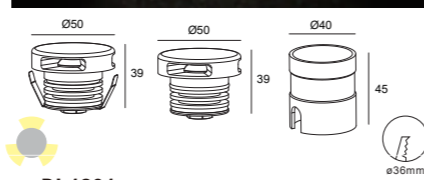

DL1201
 Power :2W/700mA/Max.3V
 CCT :2700/3000/4000K
 Flux :100lm
 CRI :≥92
 Cutout :ø36mm

Beam angle :N/A

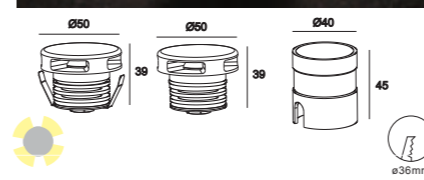
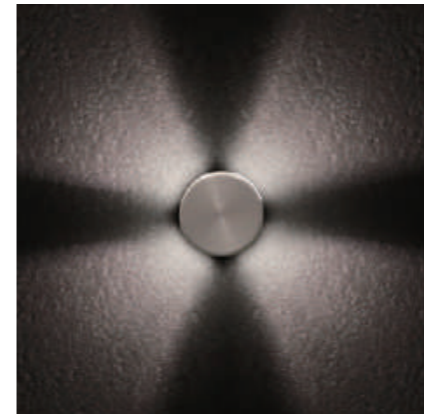
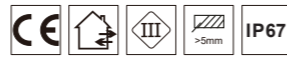

DL1202
 Power :2W/700mA/Max.3V
 CCT :2700/3000/4000K
 Flux :100lm
 CRI :≥92
 Cutout :ø36mm

Beam angle :N/A

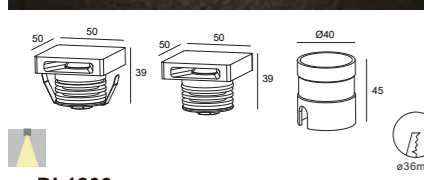
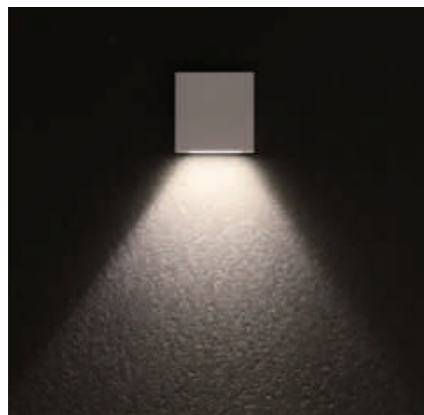

DL1203
 Power :2W/700mA/Max.3V
 CCT :2700/3000/4000K
 Flux :100lm
 CRI :≥92
 Cutout :ø36mm

Beam angle :N/A

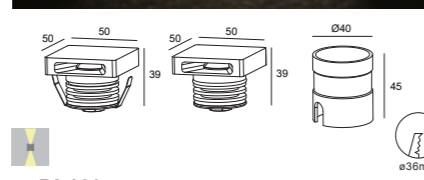
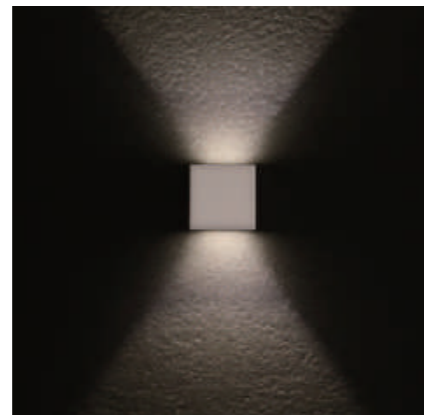

DL1204
 Power :2W/700mA/Max.3V
 CCT :2700/3000/4000K
 Flux :100lm
 CRI :≥92
 Cutout :ø36mm

Beam angle :N/A

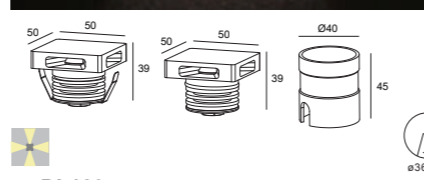

DL1205
 Power :2W/700mA/Max.3V
 CCT :2700/3000/4000K
 Flux :100lm
 CRI :≥92
 Cutout :ø36mm

Beam angle :N/A



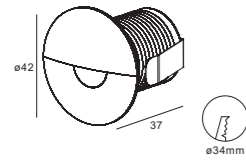
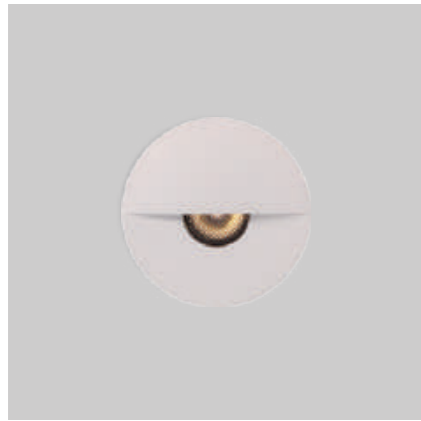

DL0573
 Power :1W/350mA 2W/700mA/Max.3V
 CCT :2700/3000/4000K
 Flux :40lm/100lm
 CRI :≥85
 Cotout :ø34mm

Beam angle :
 24° 36°

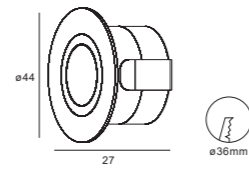
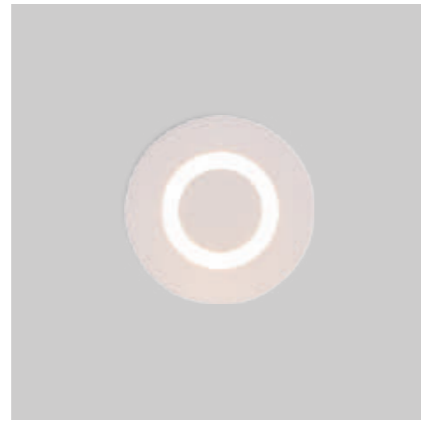

DL0729
 Power :1W/350mA 2W700mA/Max.3V
 CCT :2700/3000/4000K
 Flux :40lm/100lm
 CRI :≥85
 Cotout :ø36mm

Beam angle :N/A



ALDL0730
 Power :1W/DC24V
 CCT :2700/3000/4000K
 Flux :40lm
 CRI :≥85
 Cotout :ø36mm

Beam angle :N/A

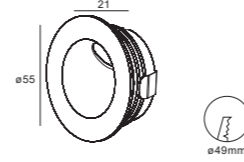

DL0668
 Power :1W/350mA/Max.3V
 CCT :2700/3000/4000K
 Flux :80lm
 CRI :≥85
 Cotout :ø49mm

Beam angle :N/A

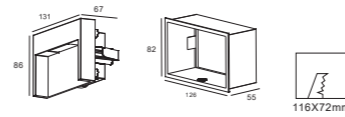

WL0045
 Power :5W/AC230V-50Hz
 CCT :2700/3000/4000K
 Flux :450lm
 CRI :≥92
 Cotout :116X72mm

Beam angle : N/A



DECK

COLOR: TW TB BV

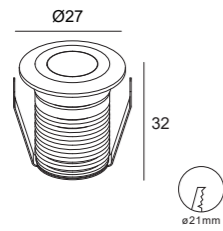

DL1334

Power :1X1W/350mA/Max.3V
:1X1W/DC24V
CCT :2700/3000/4000K
Flux :90lm/160lm
CRI :≥80
Cutout :ø21mm

Beam angle :
15° 24° 36° 60°

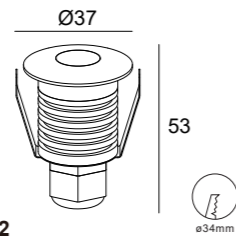

DL1332

Power :1X1W/350mA 1X2W/700mA/Max.3V
:1X1W/DC24V
CCT :2700/3000/4000K
Flux :90lm/160lm
CRI :≥80
Cutout :ø34mm

Beam angle :
15° 24° 36° 60°

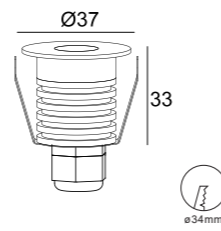
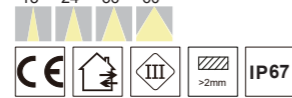

DL1333

Power :1X1W/350mA 1X2W/700mA/Max.3V
:1X1W/DC24V
CCT :2700/3000/4000K
Flux :90lm/160lm
CRI :≥80
Cutout :ø34mm

Beam angle :
15° 24° 36° 60°



DECK

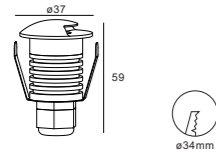

DL0195

Power :1X1W/350mA 1X2W/700mA/Max.3V
 :1X1W/DC24V
 CCT :2700/3000/4000K
 Flux :60lm/130lm
 CRI :≥80
 Cutout :ø34mm

Beam angle :N/A

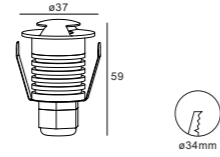

DL0194

Power :1X1W/350mA 1X2W/700mA/Max.3V
 :1X1W/DC24V
 CCT :2700/3000/4000K
 Flux :70lm/150lm
 CRI :≥80
 Cutout :ø34mm

Beam angle :N/A

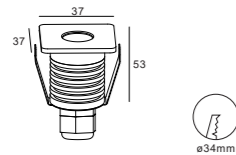

DL0193

Power :1X1W/350mA 1X2W/700mA/Max.3V
 :1X1W/DC24V
 CCT :2700/3000/4000K
 Flux :90lm/160lm
 CRI :≥80
 Cutout :ø34mm

Beam angle :
 24° 36°

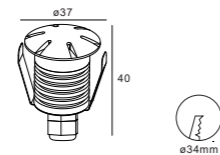
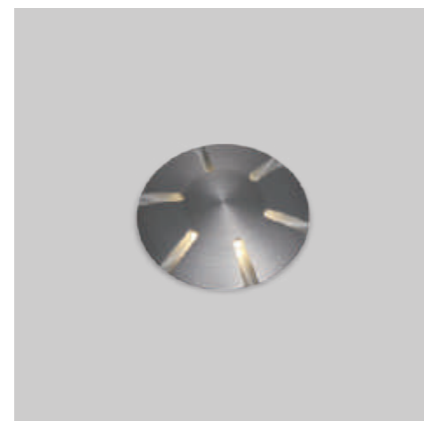

DL0333

Power :1X1W/350mA 1X2W/700mA/Max.3V
 :1X1W/DC24V
 CCT :2700/3000/4000K
 Flux :60lm/90lm
 CRI :≥85
 Cutout :ø34mm

Beam angle :N/A



DECK

COLOR: TW TB

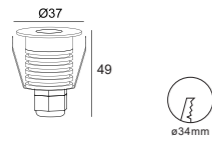

DL0471

Power :1X1W/350mA/1X2W/700mA/Max.3V
 :1X1W/DC24V
 CCT :2700/3000/4000K
 Flux :90lm/160lm
 CRI :≥92
 Cutout :ø34mm

Beam angle :
 15° 24° 36° 60°

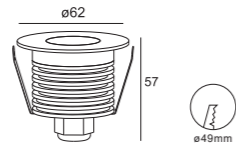

DL1484

Power :1X3W/350mA/Max.10V
 CCT :2700/3000/4000K
 Flux :270lm
 CRI :≥92
 Cutout :ø49mm

Beam angle :
 15° 24° 36° 60°

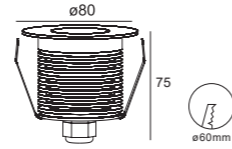

DL1485

Power :1X7W/350mA/Max.19V
 CCT :2700/3000/4000K
 Flux :650lm
 CRI :≥92
 Cutout :ø60mm

Beam angle :
 15° 24° 36° 60°

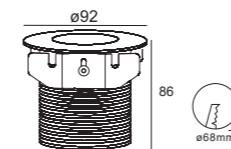

DL1486

Power :1X13W/350mA/Max.37V
 CCT :2700/3000/4000K
 Flux :1180lm
 CRI :≥92
 Cutout :ø68mm

Beam angle :
 15° 24° 36° 60°

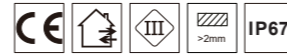

DL1488

Power :1X3W/DC24V
 CCT :2700/3000/4000K
 Flux :270lm
 CRI :≥92
 Cutout :ø49mm

Beam angle :
 15° 24° 36° 60°



DL1489

Power :1X7W/DC24V
 CCT :2700/3000/4000K
 Flux :560lm
 CRI :≥92
 Cutout :ø60mm

Beam angle :
 15° 24° 36° 60°



DL1490

Power :1X9W/DC24V
 CCT :2700/3000/4000K
 Flux :750lm
 CRI :≥92
 Cutout :ø68mm

Beam angle :
 15° 24° 36° 60°



DECK

COLOR: TW TB BV

LED UNDERGROUND LIGHT

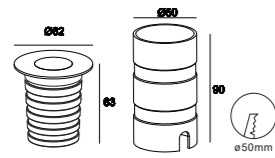
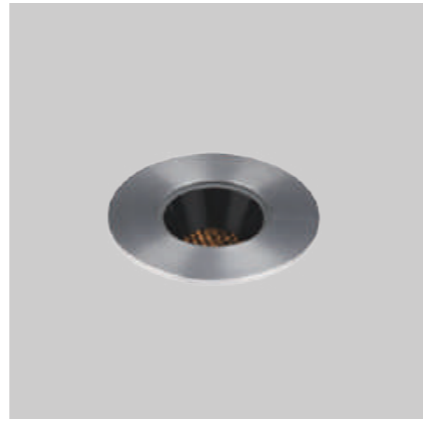

DL1271
 Power :1X3W/DC24V
 CCT :2700/3000/4000K
 Flux :270lm
 CRI :≥92

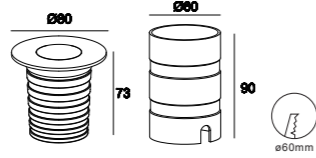
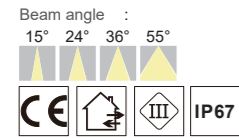

DL1167
 Power :1X7W/DC24V
 CCT :2700/3000/4000K
 Flux :560lm
 CRI :≥92

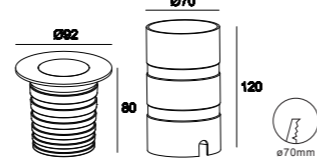
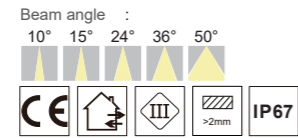

DL1168
 Power :1X9W/DC24V
 CCT :2700/3000/4000K
 Flux :750lm
 CRI :≥92

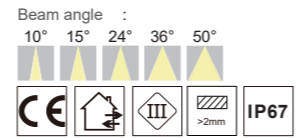

DL1171
 Power :1X13W/DC24V
 CCT :2700/3000/4000K
 Flux :1180lm
 CRI :≥92

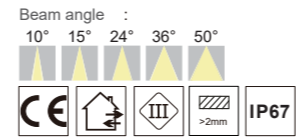

AL0012
 Power :1X8W/AC230V-50Hz
 CCT :2700/3000/4000K
 Flux :640lm
 CRI :≥92

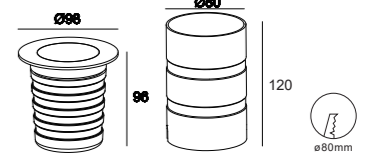
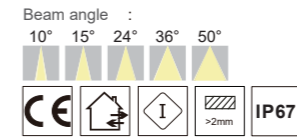

AL0013
 Power :1X15W/AC230V-50Hz
 CCT :2700/3000/4000K
 Flux :1300lm
 CRI :≥92

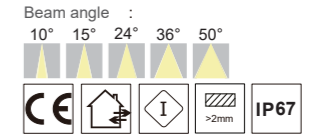



Accessories:

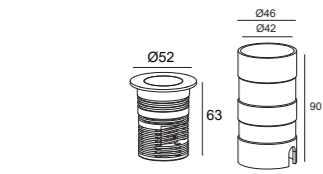
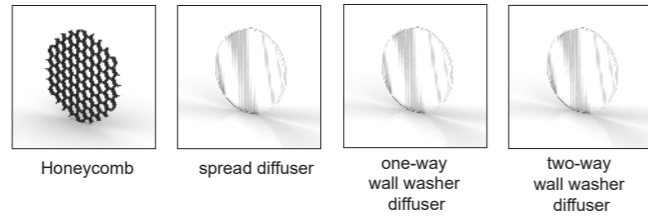

DL1228

Power :1X7W/350mA/Max.19V
 CCT :2700/3000/4000K
 Flux :560lm
 CRI :≥92

Beam angle :

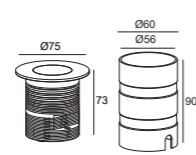

DL1234

Power :1X10W/500mA/Max.19V
 CCT :2700/3000/4000K
 Flux :960lm
 CRI :≥92

Beam angle :

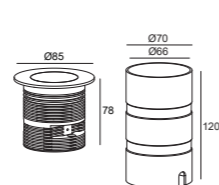

DL1240

Power :1X13W/350mA/Max.37V
 1X18W/500mA/Max.37V
 CCT :2700/3000/4000K
 Flux :1180lm/1700lm
 CRI :≥92

Beam angle :



Accessories:

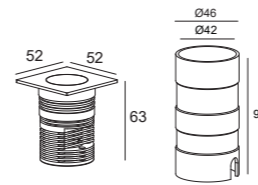
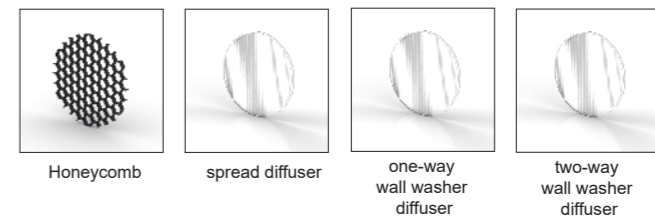

DL1229

Power :1X7W/350mA/Max.19V
 CCT :2700/3000/4000K
 Flux :560lm
 CRI :≥92

Beam angle :

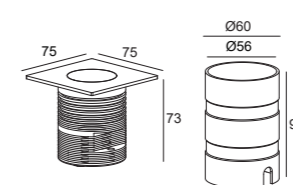

DL1235

Power :1X10W/500mA/Max.19V
 CCT :2700/3000/4000K
 Flux :960lm
 CRI :≥92

Beam angle :

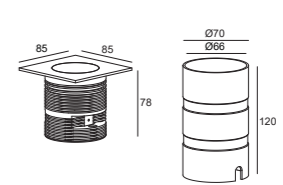

DL1241

Power :1X13W/350mA/Max.37V
 1X18W/500mA/Max.37V
 CCT :2700/3000/4000K
 Flux :1180lm/1700lm
 CRI :≥92

Beam angle :



DECK

COLOR: TW TB

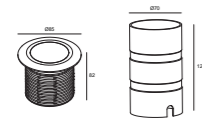

DL0938

Power	CCT	Flux	CRI
1X9W/DC24V/Max.24V	2700/3000/4000K	800lm	≥92

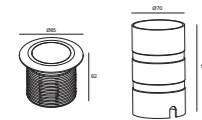

DL0939

1X9W/DC24V/Max.24V	2700/3000/4000K	800lm	≥92
--------------------	-----------------	-------	-----

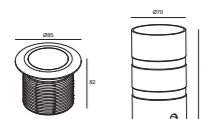

DL0940

1X9W/DC24V/Max.24V	2700/3000/4000K	800lm	≥92
--------------------	-----------------	-------	-----

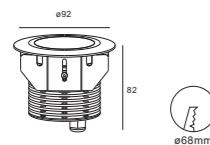
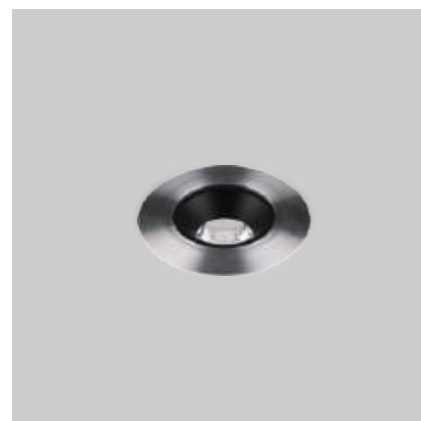
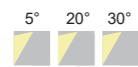

DL0995

Power :1X8W/700mA/Max.12V
 CCT :2700/3000/4000K
 Flux :760lm
 CRI :≥92
 Cotout :ø68mm

Beam angle :
7°



DECK

COLOR: TW TB BV

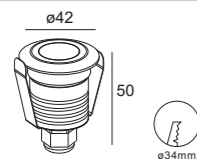

DL0827

Power :1X2W/700mA/Max.3V
 :1X1W/DC24V
 CCT :2700/3000/4000K
 Flux :90lm/160lm
 CRI :≥85
 Cutout :ø34mm

Beam angle :
 15°

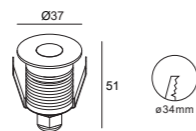

DL1396

Power :1X2W/700mA/Max.3V
 CCT :2700/3000/4000K
 Flux :160lm
 CRI :≥92/85
 Cutout :ø34mm

Beam angle :
 30°

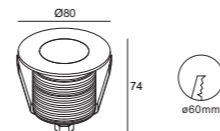
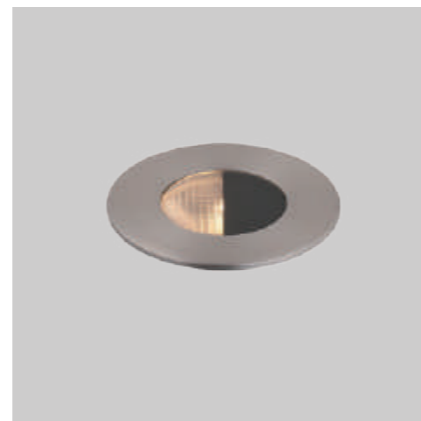

DL1397

Power :1X7W/350mA/Max.19V
 CCT :2700/3000/4000K
 Flux :690lm
 CRI :≥92/85
 Cutout :ø60mm

Beam angle :
 10°

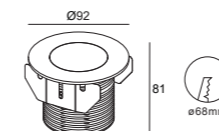

DL1398

Power :1X13W/350mA/Max.37V
 CCT :2700/3000/4000K
 Flux :1300lm
 CRI :≥92/85
 Cutout :ø68mm

Beam angle :
 10°

